

Kodak alaris

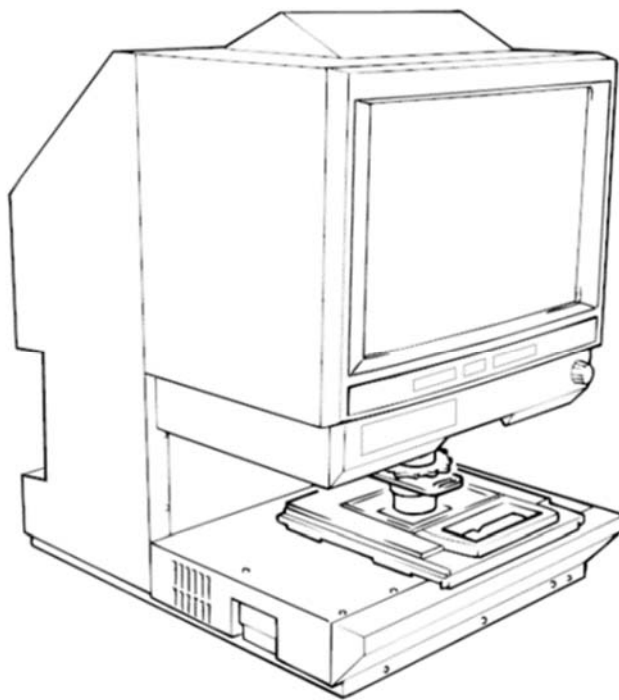

IMAGELINK 3000DV Plus Digital Scanner

User's Guide

Safety

The following information contains important information related to operator safety and may help prevent equipment problems. Make sure you observe all of the precautions listed in this manual.

Safety Precautions

- Do not modify this product, as a fire, electrical shock, or breakdown could result.
- Do not attempt to remove the covers and panels, which have been fixed to the product. Some products have a high-voltage part or a laser beam source inside that could cause an electrical shock or blindness. The operator is only allowed to slide out/ in the projection unit of the scanner.
- Only use the supplied power cord.
- Use only the specified power source voltage.
- Do not use a multiple outlet adapter to connect any other appliances or machines.
- Do not touch the plug of the power cord with a wet hand.
- Connect the plug of the power cord securely into the power outlet.
- Do not scratch, abrade, place a heavy object on, heat, twist, bend, pull on, or damage the power cord. Should any of these conditions be found, immediately turn OFF the power switch, unplug the power cord from the power outlet, and call your Service Representative.
- Do not use an extension cord. Contact your Service Representative if an extension cord is required.
- Do not place any container that contains water, metal clips or other small metallic objects on this product.
- Should a piece of metal, water, or any other similar foreign matter get inside the product, immediately turn OFF the power switch, unplug the power cord from the power outlet, and call your Service Representative.
- If this product becomes inordinately hot or emits smoke, or unusual odor or noise, immediately turn OFF the power switch, unplug the power cord from the power outlet, and then call your Service Representative. A fire or electrical shock could result if you continue to use the product.
- Connect the plug of the power cord to a wall socket-outlet that is equipped with a grounding terminal.
- If this product has been dropped or the cover is damaged, immediately turn OFF the power switch, unplug the power cord from the power outlet, and call your Service Representative.
- Do not use flammable sprays, liquids, or gases near this product.
- Do not let any object plug the ventilation holes of this product.
- Do not install this product at a site that is exposed to direct sunlight, or near an air conditioner or heating apparatus.
- Do not place the product in a dusty place, or a site exposed to soot or steam, near a kitchen table, bath, or a humidifier.
- Do not place this product on an unstable or tilted bench, or in a location subject to a lot of vibration and shock
- After installing this product, mount it on a secure base.
- Do not store toner and PC drum units near a floppy disk or watch that are susceptible to magnetism.
- Do not place any objects around the power plug.
- The wall socket-outlet shall be installed near the machine and shall be easily accessible as the power plug may be difficult to pull out when an emergency occurs.
- Always use this product in a well-ventilated location.
- Whenever moving this product, be sure to disconnect the power cord and other cables.
- When unplugging the power cord, be sure to hold onto the plug.
- Do not store toner or PC drum units and other supplies and consumables in direct sunlight and high temperature and humidity.
- Do not attempt to replace the toner unit and PC drum unit in a place exposed to direct sunlight.
- Do not unpack a toner unit or PC drum unit until the time of use. Do not leave an unpacked unit standing; install it immediately.
- Do not keep toner and PC drum units in an upright position or upside down.
- Do not throw or drop a toner unit or PC drum unit.

- Do not use this product in an area where ammonia or other gases or chemicals are present.
- Do not use this product in an environment with a temperature outside the range specified in the Operator's Manual.
- Do not attempt to feed stapled paper, carbon paper or aluminum foil through this product.
- Do not touch or scratch the surface of the toner unit developing roller and the PC drum.
- Use only the recommended supplies and consumables.

Safety rules

- The unit should be kept free from moisture, dirt, dust and exposure to heat and direct sunlight at all times.
- Keep hands, hair and clothing away from rollers and other moving parts.
- Before removing the Projection Lamp Unit, confirm that the machine is turned "OFF".
- Be sure that the proper voltage is used and that the machine is well grounded. The use of electrical extension cords is strongly discouraged.
- For best performance, use the recommended supplies and consumables with this unit.
- Do not attempt to remove any cover that is secured.

FCC Part 15 - Radio Frequency Devices (For U.S.A. Users)

This device complies with Part 15 of the FCC Rules.

Operation is subject to the following conditions:

- This device may not cause harmful interference, and this device must accept any interference received, including interference that may cause undesired operation.

WARNING

This equipment has been tested and found to comply with the limits for a Class A digital device, pursuant to Part 15 of the FCC Rules. These limits are designed to provide reasonable protection against harmful interference when the equipment is operated in a commercial environment. This equipment generates, uses, and can radiate radio frequency energy and, if not installed and used in accordance with the instruction manual, may cause harmful interference to radio communications. Operation of this equipment in a residential area is likely to cause harmful interference in which case the user will be required to correct the interference at his own expense.

The design and production of this unit conforms to FCC regulations, and any changes or modifications must be registered with the FCC and are subject to FCC control. Any changes made by the purchaser or user without first contacting the manufacturer will be subject to penalty under FCC regulations.

Interference-Causing Equipment Standard (ICES-003 ISSUE 4) (For Canada Users)

This Class A digital apparatus complies with Canadian ICES-003.

Cet appareil numérique de la classe A est conforme à la norme NMB-003 du Canada.

CE Marking (Declaration of Conformity) (For European Users)

This product complies with the following EU directives:
2006/95/EC and 2004/108/EC directives.

This declaration is valid for the area of the European Union (EU) only.

This device must be used with shielded interface cable and shielded network cable.

The use of non-shielded cable is likely to result in interference with radio communications and is prohibited under rules.

Acoustic Noise

Machine Noise Regulation 3 GSGV, 18.01.1991: The sound pressure level at the operator position according to EN27779 is equal to or less than 70dB (A).

European Union



This symbol indicates that when the last user wishes to discard this product, it must be sent to appropriate facilities for recovery and recycling.

Battery Information

This product contains a Lithium Ion button cell battery. This battery can only be removed or replaced by a qualified Service Engineer.

Safety Information (34PPM Video Laser Printer)

WARNING: This symbol warns against a potential for burns.



The inside of the printer has areas subject to high temperature, which may cause burns. When checking the inside of the unit for malfunctions such as a paper misfeed, do not touch the locations (around the fusing unit, etc.) which are indicated by a “CAUTION HOT” label.

Laser Safety: This printer is a page printer which operates by means of a laser. There is no possibility of danger from the laser, provided the printer is operated according to the instructions provided in this manual.

Since radiation emitted by the laser is completely confined within protective housing and external covers, the laser beam cannot escape from the machine during any phase of user operation.

This printer is certified as a Class 1 laser product: This means that the printer does not produce hazardous laser radiation.

Internal Laser Radiation: This product employs a Class IIIb Laser Diode that has an invisible laser beam. The Laser Diode and Scanning Polygon Mirror are incorporated in the print head unit.

Maximum average radiation power: 37 μ W at laser Aperture of mirror unit.

Wave length: 770-800 nm

The print head (in the interior of the printer in front of the toner cartridge) consists of the print head unit and the mirror unit. The laser beam is emitted from the print head unit, passes through the mirror unit, then is radiated through the laser aperture of the mirror unit to the interior of the printer.

WARNING: The print head unit is NOT A FIELD SERVICE ITEM. Therefore, the print head unit should not be opened under any circumstances

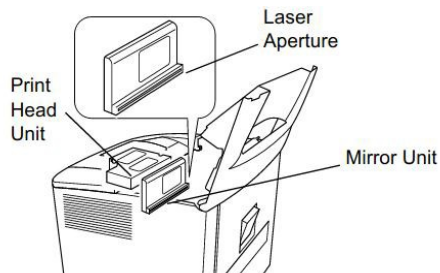

For United States

CDRH Regulations: This printer is certified as a Class I laser product under the Regulation Performance Standard according to the Food, Drug, and Cosmetic Act of 1990.

Compliance is mandatory for laser products marketed in the United States, and is reported to the Center for Devices and Radiological Health (CDRH) of the U.S. Food and Drug Administration (FDA) of the Department of Health and Human Services (DHHS). This means that the product does not produce hazardous laser radiation.

The label shown below indicated compliance with the CDRH regulations and must be attached to laser products marketed in the United States.

CAUTION: Use of controls, adjustments or performance of procedures other than those specified in this manual may result in hazardous radiation exposure.

This is a semiconductor laser. The maximum power of the laser diode is 15mW, and the wavelength is 770-800 nm.

All other users

WARNING: Use of controls, adjustments of performance or procedures other than those specified in this manual may result in hazardous radiation exposure.

This is a semiconductor laser. The maximum power of the laser diode is 15mW, and the wavelength is 770-800 nm.

For Denmark

ADVARSEL: Usynlig laserstråling ved åbning, når sikkerhedsafbrydere er ude af funktion. Undgå udsttelse for stråling. Klasse 1 laser produkt der opfylder IEC60825 sikkerheds kravene.

For Finland, Sweden

VAROITUS! Laitteen käyttäminen muulla kuin tässä käyttöohjeessa mainitulla tavalla saattaa altistaa käyttäjän turvallisuusluokan 1 ylittävälle näkymättömälle lasersäteilylle

VARNNING: Om apparaten används på annat sätt än i denna bruksanvisning specificerats, kan användaren utsattas för osynlig laserstråling, som överskrider gränsen för laserklass 1.

VARO: Avattaessa ja suojalukitus ohitettaessa olet alttiina näkymättömälle lasersäteilylle. Aja katso sateeseen.

WARNING: Osynlig laserstråining när denna del är öppnad och spärren är urkopplad. Betrakta ej stråien.

For Norway

ADVARSEL: Dersum apparatet brukes på annen måte enn spesifisert i denne bruksanvisning, kan brukeren utsettes for usynlig laserstråling som overskrider grensen for laser klasse 1.

Dette er en halvleder laser. Maksimal effekt til laserdioder er 15mW, og bolgelengde er 770-800 nm.

WARNING LABEL

Three laser caution labels are attached to the inside of the machine as shown below.

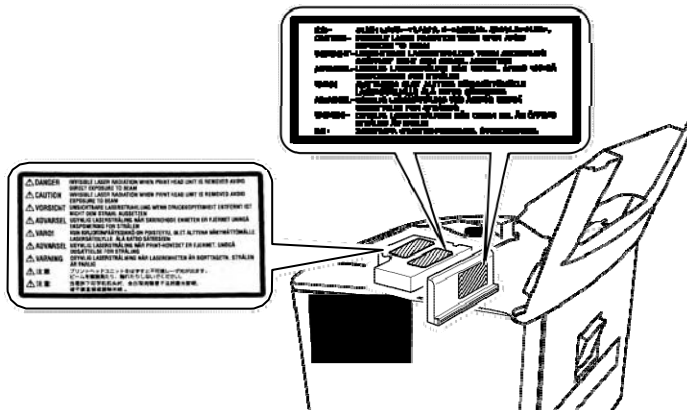

OZONE RELEASE (For all Users)

During printer operation a small quantity of ozone is released. This amount is not large enough to cause any adverse affects or harm. However, be sure the room where the machine is being used has adequate ventilation, especially if you are printing a high volume of materials, or if the machine is being used continuously over a long period.

WARNING LABEL

A laser safety label is attached to the outside of the machine as shown below.

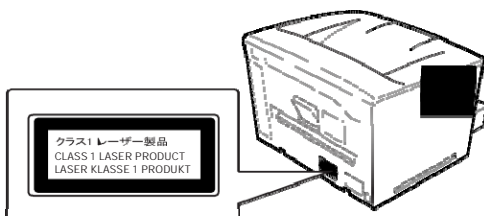

Contents

1 Overview	1-1
Product description	1-1
Installation	1-2
Power source	1-2
Grounding	1-3
Space requirements	1-3
Operating environment	1-4
System configuration	1-4
Scanner components	1-5
Optional accessories	1-7
Turning the power on and off	1-9
2 Control Panel and Functions	2-1
Control panel - Standard	2-1
Using the Shift function on Control Panel 1	2-4
Image Processing features	2-7
3 Using the Scanner	3-1
Selecting a projection lens	3-2
Replacing the projection lens	3-3
Positioning the film image	3-4
Zooming, focusing and image rotation	3-5
Selecting the film type	3-6
Selecting the paper size	3-7
Using the Auto Paper Selection function	3-7
Using the Auto Film Format Selection function	3-8
Selecting the Print Position	3-8
Selecting the Image density	3-9
Entering the number of prints to be made	3-10
Adjusting image processing features	3-11
Using Auto Masking	3-11
Manual Masking panels (option)	3-12
Using Manual Masking	3-12
Using Centering and Fit	3-15
Using the Cycle Print mode	3-16
Selecting the Connection mode	3-17
Selecting the resolution	3-18
Registering the Job Program	3-18
Calling the Job Program	3-19
Using Electronic Zoom	3-19
Adjusting screen illumination	3-20

4 Printer Functions	4-1
Printer components	4-1
Paper specifications	4-3
Loading paper into the paper feeding tray	4-3
Loading paper in the paper cassette	4-4
Replacing the toner cartridge	4-8
Replacing the exhaust filter	4-11
Troubleshooting	4-11
Misfeed clearing procedure	4-11
Clearing a misfeed from the paper feeding tray	4-12
Clearing a misfeed from the paper cassette	4-12
Clearing a misfeed from inside the printer	4-12
Printer maintenance	4-14
Cleaning the paper cassette pickup rollers	4-14
5 Maintenance	5-1
Cleaning the scanner	5-1
Replacing the projection lamp	5-3
6 Troubleshooting	6-1
Printer/Scanner malfunctions	6-1
Appendix A Specifications	A-1
Appendix B User and System Settings	B-1
Appendix C Key Operator Information	C-1
Appendix D Setting System Default Values	D-1
Changing settings with the User mode	D-1
Entering and exiting the User mode	D-2
Settings in each User mode function	D-3

1 Overview

This Operator's Manual provides information and procedures for using the IMAGELINK 3000 DV Plus Digital Scanner. Following is a summary of what is included:

Chapter 1, *Introduction* — provides general information about the IMAGELINK 3000 DV Plus Digital Scanner including a product description, installation information, environmental specifications, an overview of external components, and how to turn the scanner on and off.

Chapter 2, *Control Panel and Functions* — provides a list of the icons found on the Operator Control Panel and how to use them.

Chapter 3, *Using the Scanner* — provides procedures on how to use the scanner, including selecting and installing the lens, zooming and focusing images, rotating images, selecting the paper size, print position and image density, adjusting the image processing features and how to print and scan the displayed image.

Chapter 4, *Printer Functions* — provides instructions for using and maintaining the printer.

Chapter 5, *Maintenance* — provides maintenance procedures for the scanner, including replacement procedures for replacing the projection lamp.

Chapter 6, *Troubleshooting/Messages* — provides information on analyzing and correcting operating/printing problems or errors.

Appendix A — provides specifications for the IMAGELINK 3000 DV Plus Digital Scanner and 34 ppm Video Laser Printer.

Appendix B — user and system settings can be changed by you or your Service Representative. This appendix provides the factory settings and a description of those settings.

Appendix C — provides Key Operator information along with a chart that you can record system information, such as scanner/printer model, accessory names and serial numbers.

Appendix D — provides information on User and System settings.

Product description

The IMAGELINK 3000 DV Plus Digital Scanner scans images and outputs to the optional 34 ppm Video Laser Printer through a built-in video interface. The 3000 DV Plus Digital Scanner is ideal for medium- to high-volume scanning of all formats of media from microfiche, jackets, aperture cards, 16 and 35 mm roll film and 16 mm M and ANSI cartridges.

Installation

Placement of the unit in the environment described below will ensure optimal performance throughout the long life of service for which it was designed.

- A well-ventilated place.
- An area which is free from ammonia or other organic gases.
- A place which has easy access to a power wall socket-outlet so that the unit may be easily plugged in and unplugged.
- Any area free from direct sunlight.
- A place which is out of the direct air stream of an air conditioner, heater or ventilator and is not subject to extremely high or low temperatures or humidity.
- A stable location with a flat surface that is not subject to undue vibration.
- A place that is free from any object that would block the heat exhaust duct of the printer.
- A place away from curtains or anything else that is easily flammable.
- An area that is safe from spilled water or other liquids.
- A dust-free location.

NOTE: If the scanner is located near a window, do not face the screen towards the window.

Power source

- Use a power source with minimal voltage fluctuation.

Power Source: 50Hz-60Hz Voltage

fluctuation: within $\pm 10\%$

Frequently fluctuation: within $\pm 3\%$

NOTE: For detailed specifications, see Appendix A.

- Do not exceed the capacity of the outlet, especially when sourcing other appliances from the same outlet.
- The outlet should be located near the unit and be easily accessible so the power cord can be unplugged immediately if necessary.
- NEVER connect any other appliances or machines by means of a multiple socket to the outlet being used for the unit.
- Make sure that the power cord and extension cord do not become caught in any mechanism of the system. Do not allow either the power or extension cord to become caught underneath the weight of the unit.

Grounding

To prevent electrical shocks caused by electrical leakage, always ground the printer.

- Connect the grounding wire to:
 - the ground terminal of the outlet
 - a grounding contact that complies with the local electrical standards
- NEVER connect the grounding wire to a gas pipe, the grounding wire for a telephone, or a water pipe.

Space requirements

Scanner

The illustration below provides the clearance dimensions.

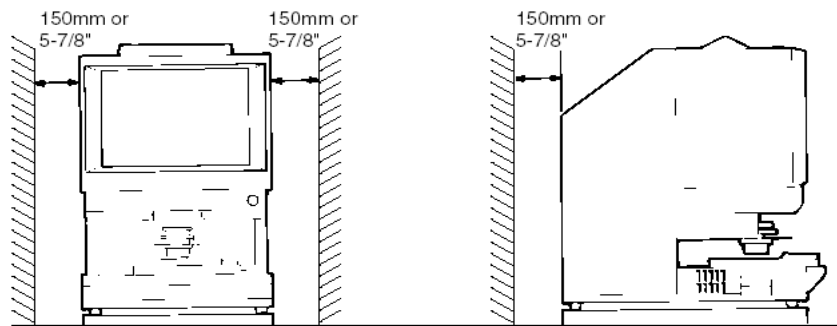

System Printer

For ease of operation, maintenance and replenishment of supplies, the minimum clearance shown below is required. Install the unit in an area that allows easy access.

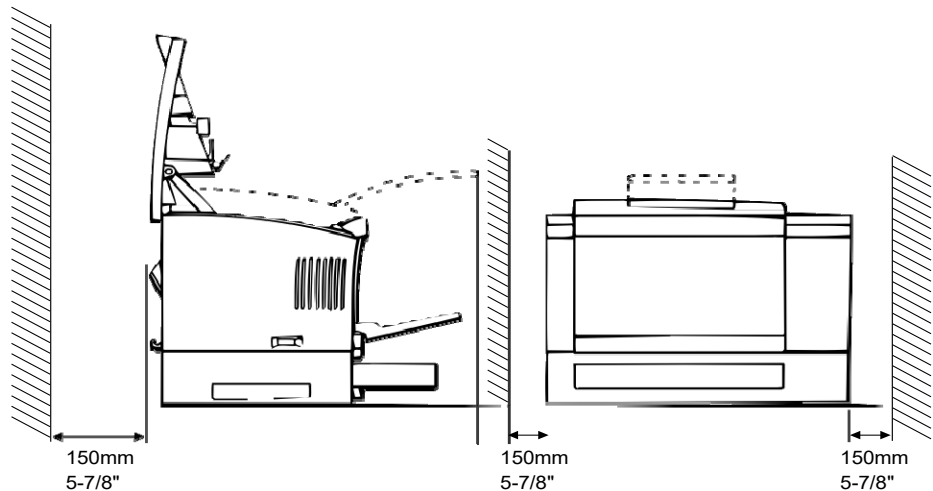

Operating environment

The environmental requirements for operating the system are as follows:

Temperature: 10° to 35°C (50 to 95°F) with a maximum fluctuation of 10°C (18°F) per hour.

Humidity: 15 to 85% with a maximum fluctuation of 20% per hour.

System configuration

This scanner is available in the following configurations:

Printer mode (connected to the printer)

The scanner is connected to a dedicated MSP3500 34 ppm Video Laser Printer, allowing scanned images to be printed out directly.

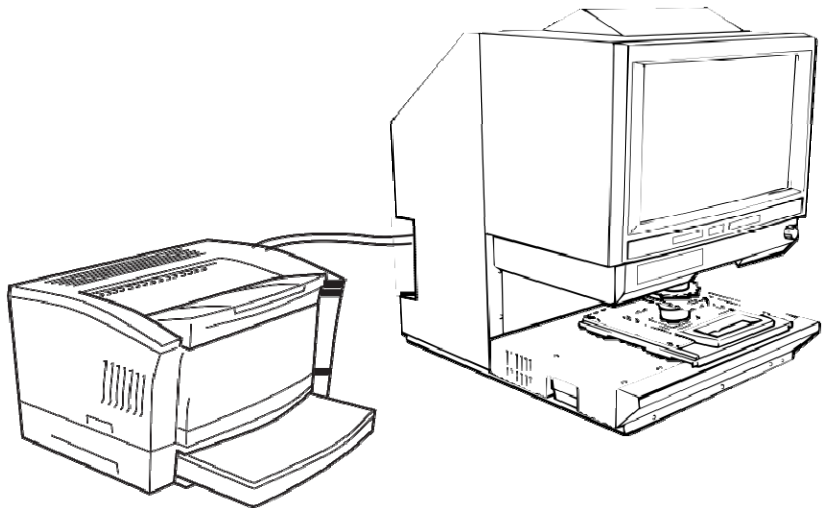

PC mode (connected to a personal computer via a USB 2.0 cable)

The scanner is connected to a personal computer and the scanned images can be uploaded to the computer.

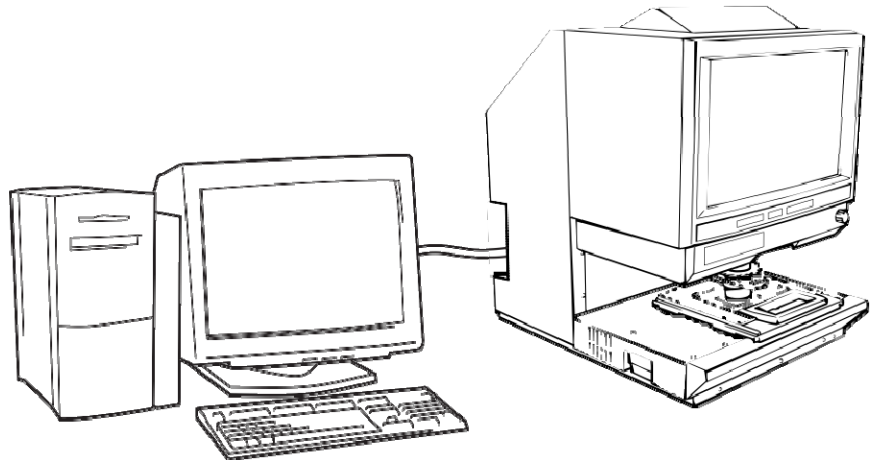

You can use the control panel to connect to a personal computer (PC mode) or a printer (PR mode).

Scanner components Front view

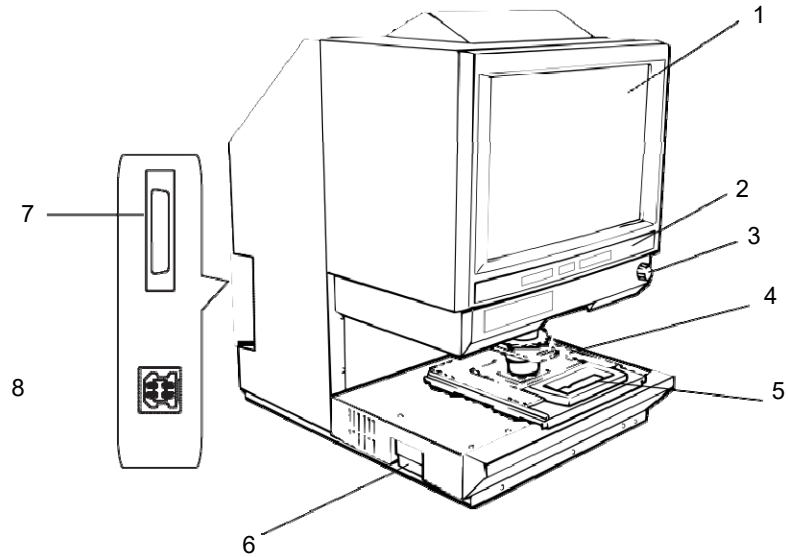

- 1 Screen** — the image from the film is displayed for viewing on the screen. The frame on the screen marks the data reading range.
- 2 Control Panel** — most operations are controlled from the keys and indicators on the control panel. See Chapter 2, *Control Panel and Functions* for more information.
- 3 Image Rotation Knob** — use this knob to rotate the image on the screen.
- 4 Projection Lens (optional)** — several projection lenses are available to change the size and adjust the focus of the image. For more information on the projection lenses, see the next section.
- 5 Fiche Carrier 5 (optional)** — supports the viewing of microfiche.
- 6 Projection Lamp Unit** — contains the Projection Lamp (halogen lamp) which projects the film image onto the screen.
- 7 Printer Connector** — connects the scanner to the printer through an interface cable.
- 8 USB 2.0 Connector** — connects the scanner to the personal computer through a USB cable.

Rear view

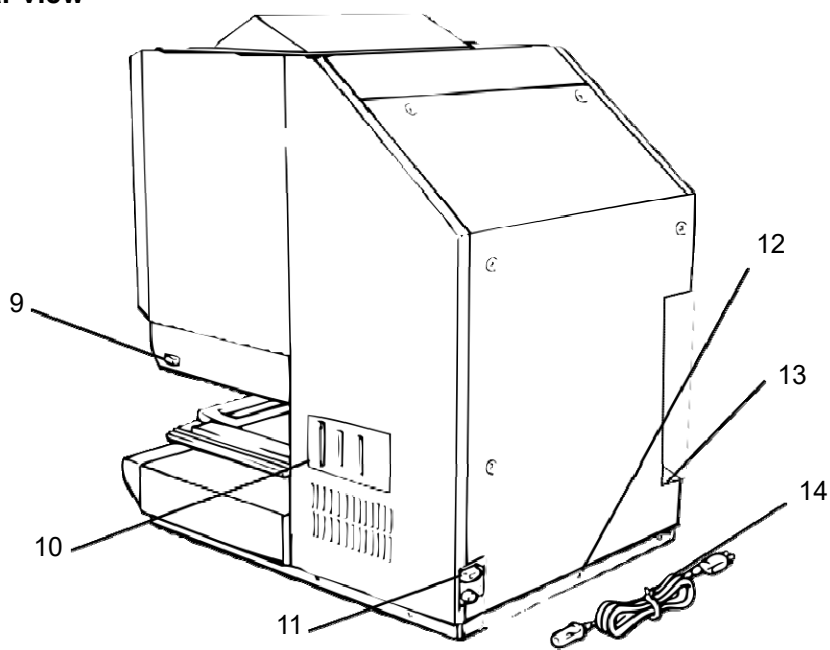

- 9 Power Switch** — used to turn the power to the unit on and off.
- 10 Connectors** — provides connection points for the various options (Film Carrier and Controller).
- 11 Power Cord Socket** — plug the power cord included with the scanner into this socket.
- 12 Fuse Holder** — protects the circuit from overloading. (Ratings: 6A, 250V)
- 13 Total Counter** — shows the total number of prints made regardless of paper size.
- 14 Power Cord** — connects the scanner to the power wall socket-outlet.

Optional accessories

Optional accessories are available for the scanner. Contact your E PM Representative for more information about these accessories.

Projection Lenses — several projection lenses are available to change the size and adjust the focus of the image. Four lenses are available:



Single lens 7.5X



Zoom lens 9-16X



Zoom lens 13-27X

Zoom lens 20-50X



Auto-retrieval Controllers

Mini Mars-2 Controller — for automatic reading of 16 mm Cartridge Microfilm using up to 2-level image marks.



Mars IV Controller — for automatic reading of 16 mm Cartridge Microfilm using up to 3-level image marks.



NOTE: For information related to *Kodak* IMC Code please contact your local supplier or *Kodak* Service and Support.

Both controllers may be used in conjunction with the RFC-15A or RFC-15M Carriers.

Film carriers



Fiche Carrier-5 — for use with jackets, microfiche and aperture cards.

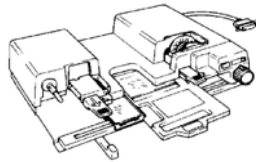

UC-2 — a motorized carrier for semi-automatic loading of 16 and 35 mm open spool film, microfiche, aperture cards, jackets.

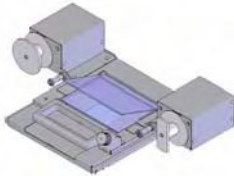

UC8 — a motorized carrier for roll films but manual threading.

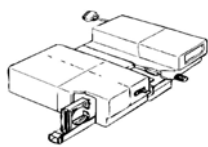

RCF-15A — for automatic loading of 16 mm ANSI Clip Cartridge Microfilm (Open Spool Adapter option).

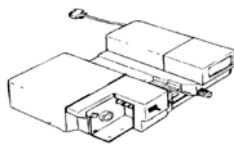

RCF-15M — for automatic loading of 16 mm 3M Type Cartridge Microfilm.

Turning the power on and off

To turn the power on:

- Press the power switch of the scanner to the (I) On position.

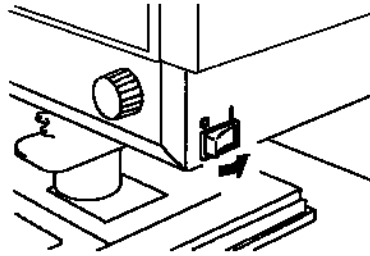

- Press the power switch of the printer to the (I) On position.

The indicators on the control panel light up and the system starts the initialization operation. When the Wait symbol goes out, the system is ready for printing.

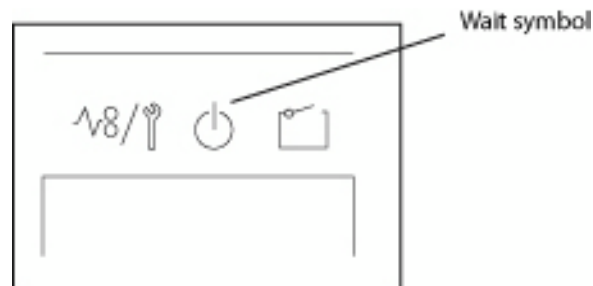

NOTE: If you load the film in the Film Carrier and press Start while the printer is warming up, you can scan and memorize the film image of about 9 pages (letter or A4 size/400 dpi). The printer allows that print process to be started as soon as the printer completes warming up.

Both ends of the Exposure display blink. If you want this function disabled, contact your Service Representative.

To turn the power off

- Press the power switch of the scanner to the O (Off) position.

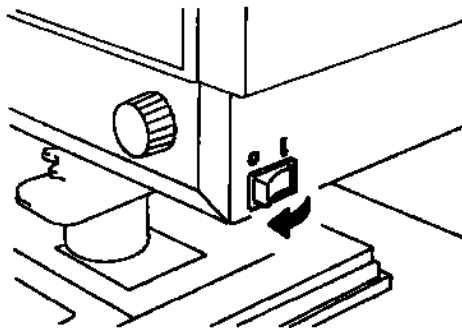

- Press the power switch of the printer to the O (Off) position.

Auto Power Save/ Projection lamp functions

This system provides two functions that help to decrease power consumption:

- The Auto Power Save function that automatically shuts down power to the printer heater.
- The Auto Projection Lamp OFF function that automatically turns off the Projection Lamp of the scanner.

Both are activated when the system is left idle for a specified period of time.

These functions may be disabled or enabled. When enabled, timing can be selected to 30 or 60 minutes. The default for both of these functions is Disabled. Contact your Service Representative for more information.

When the system is in the Auto Power Save mode, each outside segment of the Multi-Print Display LEDs light up sequentially.

2 Control Panel and Functions

Following are descriptions of the Control Panel functions. Some functions are available by using the Shift key and some of the functions provide access to optional accessories. This chapter provides an overview of each function and a description of image processing features. Chapter 3, *Using the Scanner*, provides procedures on how to use each function.

Control Panel - Standard

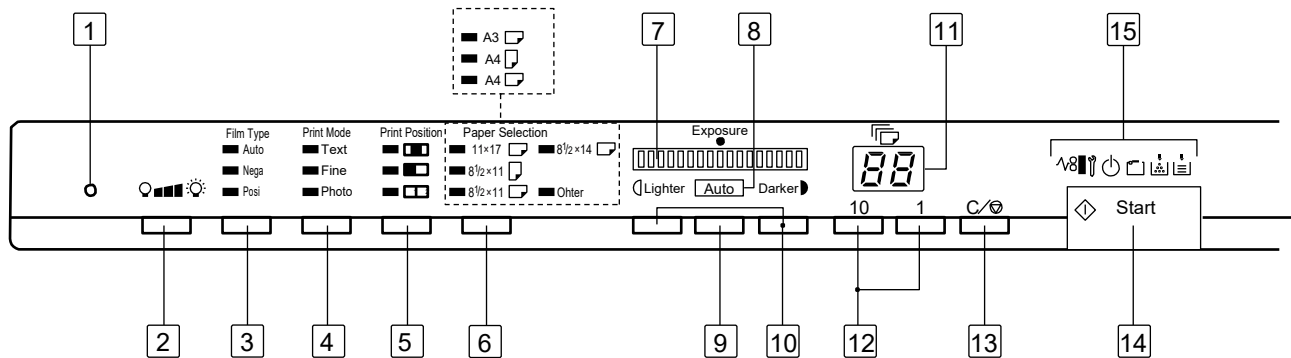



1 **Memory Input Key** — to store one of the following functions into the memory of the scanner, set one of the functions on Control Panels 1 and 2 and then press the pinhole with the head of a pen or other device. The next time the scanner is turned on, that function will appear as a default setting until a new one is entered. A maximum of three settings can be memorized.





- Negative or positive
- Print mode
- Print position*
- Paper size*
- Print image density
- Exposure mode
- Centering or Fit
- Manual Masking
- Auto Masking
- Auto Skew Correction
- Horizontal Area setting
- Vertical Area setting
- Electronic Zoom magnification
- Resolution
- Image Distortion Correction

* If the current paper tray or cassette is different from the paper tray/cassette that is loaded when the Paper size setting was made, Center Image Print is selected for the print position and the current paper size is selected.

NOTE: If you do not press the pinhole within 60 seconds after a setting has been made with the Auto Reset function set to On, the previous setting remains valid.

- 2 **Lamp Illuminance** — manually adjusts the Projection Lamp illuminance. When the Projection Lamp is Off, it can be turned On again by pressing any key.
- 3 **Film Type** — rotates between **Auto**, **Nega**, and **Posi** each time the key is pressed.
 - **Auto**: the scanner automatically determines between the film type options of negative or positive for print production.
 - **Nega**: select when using negative film. Dark and light values of the print will be reversed.
 - **Posi**: select when using positive film. Dark and light values of the print will be consistent with the image on film.
- 4 **Print Mode** — allows you to fine-tune the image quality of the print according to the original being used. Rotate between **Text**, **Fine** and **Photo** with every press of this key.
 - **Text**: for use with text images.
 - **Fine**: for use with lower grades of film.
 - **Photo**: for use with photo images.
- 5 **Print Position** — selects the portion of the image displayed on the screen to be printed.
 - **Center** : the image in the center of the screen is printed.
 - **Left** : the image on the left half of the screen is printed.
 - **Page-by-Page** : The images on both the left and right sides of the screen are printed consecutively on 8 1/2 x 11" (A4) sheets of paper. This option is only available when 8-1/2 x 11" (A4) paper is selected.
- 6 **Paper Selection** — allows you to select either **PC** or **PR** mode.
 - **PC mode**: selects the scanning size. *When scanning the file image except standard size, the **Other** lamp is lit.*
 - **PR mode**: selects the size of paper to be used for printing. When the paper feeding tray is loaded with 8 1/2 x 11" (A4) paper and the paper in the paper cassette contains 11 x 17" (A3) paper, pressing this key rotates through the **Auto**, **Paper Feeding Tray**, and **Paper Cassette** options. Both the 8 1/2 x 11" (A4) and 11 x 17" (A3) indicators will illuminate when **Auto** is selected.
- 7 **Exposure display** — indicates the current density level of the printed image.
- 8 **Exposure Mode indicator** — Auto Exposure mode is indicated when the green Auto light is on. The green Auto light turns off when the scanner is in the Manual Exposure mode.
- 9 **Exposure Mode** — press to select between the **Auto** or **Manual** Exposure modes.

- 10 **Exposure Adjustment** — adjusts the density of the image to be printed during the **Auto** or **Manual Exposure** mode.
 - **Darker**: supports darker image density.
 - **Lighter**: supports lighter image density.
- 11 **Multi-Print display** — displays the number of prints to be made. Also displays corresponding codes in the event of a malfunction or paper misfeed. The blinking number in this display indicates the print cycle in progress.
- 12 **Multi-Print** — used to input the number of prints to be made. This function is only available in PR mode.
 - **10**: increases the number of prints to be made in increments of 10 (10, 20, 30 ...90, etc.)
 - **1**: increases the number of prints to be made in increments of 1 (1, 2, 3 ... 9, etc.)
- 13 **Clear/Stop** — clears the setting on the Multi-Print display, resets the display to 1 or stops a multi-print cycle. This function is only available in PR mode.
- 14 **Start** — starts the print (scan) process of the displayed image.
- 15 **Indicators:**

	Misfeed/Call : lights up when a paper misfeed or malfunction occurs.
	Wait : lights when the scanner is initializing, and the printer is warming up.
	Closure Failure : lights up if the printer cover is open.
	Add Toner : blinks when the toner cartridge of the printer is low and lights up when the cartridge is completely out of toner.
	Add Paper : lights up when the printer is not loaded with the selected paper size or when the paper feeding tray or paper cassette has run out of paper with Auto Paper selected.

Using the Shift function on Control Panel 1

When you use the Shift function (Clear/Stop key) on Control Panel 1, other options are available.

Control Panel 1 - Shift Function

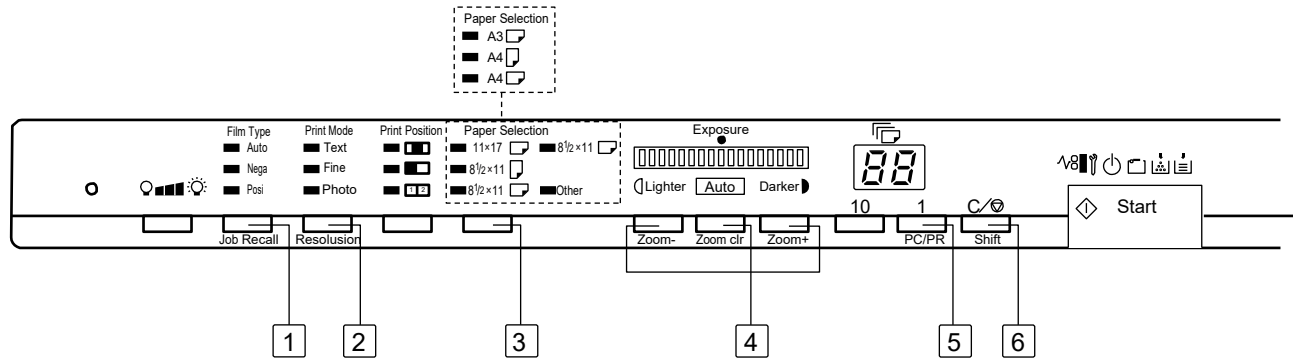



- 1 **Job Recall** — when pressed with the Shift key, the program registration locations (1J, 2J and 3J) are called. Each time this key is pressed while the Shift key is held down, the display rotates through 1J, 2J and 3J.
- 2 **Resolution** — sets the resolution of the scanner.
 - When the scanner is connected to the printer, available resolutions are: 400 dpi (4H) and 600 dpi (6H).
 - When the scanner is connected to the PC through PowerFilm Application Software, available resolutions are: 200, 300, 400, 600 and 800 dpi (2H, 3H, 4H, 6H and 8H respectively).
- 3 **User Mode** — when pressed with the Shift key, enters into User Mode. See *Appendix D, Setting System Default Values* for more information.
- 4 **Electronic Zoom** — sets zoom magnification.
 - **Zoom+:** when pressed with the Shift key, the magnification is increased by an increment of 0.01X (up to 2.00X).
 - **Zoom clr:** when pressed with the Shift key for 1 second, clears the current zoom setting.
 - **Zoom-:** when pressed with the Shift key, the magnification is decreased by a decrement of 0.01X (down to 0.50X).
- 5 **PC/PR** — when pressed with the Shift key, the connection to the PC or printer is selected.
- 6 **Shift** — the Shift key must be pressed when you want to access one of the functions described in this section.

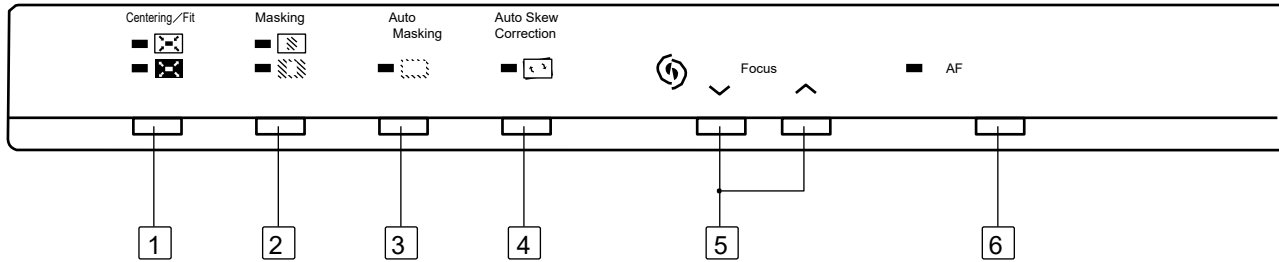

Control Panel 2



1 Centering/Fit key — when pressed, enables or disables the Centering and Fit functions. When **Auto Masking**, **Trimming** or **Masking** are set to **Off**, Auto Masking will automatically be enabled when **Centering** is selected.

- **Centering** : centers all masked images onto the printed page.
- **Fit** : enlarges the displayed image to fill the page when printed. Enlargement is only to the full length or width of the paper, whichever is achieved first.

2 Masking — when pressed, cycles through **Off**, **Trimming** and **Masking** if the system has the optional Manual Masking Kit.

- **Off**: no masking or trimming will be done.
- **Masking** : prints only the image outside of the area that is defined on the screen.
- **Trimming** : prints only the area of the image that is defined on the screen.
 - If Trimming is selected from the Off state, the previously entered settings for Centering/Fit and Manual Masking are applied.
 - From Trimming, when **Masking** is selected, the Centering/Fit setting is disabled and the previous settings for the Masking area are applied.
 - The Manual Masking area will be cancelled whenever **Off** is selected from the Masking state.
 - **Trimming** or **Masking** are not available through the Auto Masking function.

3 Auto Masking — turns auto masking on or off. Auto masking omits the frame (non-image area) of a printed film image. Auto masking is only available in the PR mode.

- The previous Centering/Fit setting is applied when On is selected from the Off state.
- If Off is selected from the On state, Centering/Fit is disabled.
- Auto Masking is not applicable with Masking or Trimming.

4  Auto Skew Correction — turns auto skew on or off. When auto skew is on, the indicator is lit and any skew of the image will be corrected during printing.

After printing, the skew is retained by default. Contact your Service Representative to change the default.

5 Manual Focus — press the up or down arrow keys to manually adjust the focus of the displayed image.



6 AF (Auto Focus) — when pressed the system automatically finds the optimum focus for the displayed image. When the image is in focus, the Auto Focus LED will turn off.

NOTE: If an image is not properly centered or the contrast and density of the image is such that it causes the Auto Focus to error, the LED will blink. The LED will turn off when the Manual Focus keys or the Auto Focus key is pressed.

Image processing features

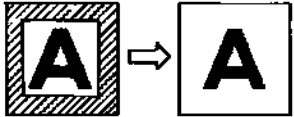
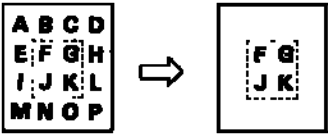
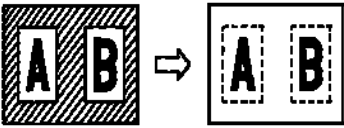
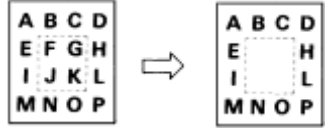
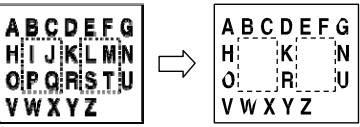
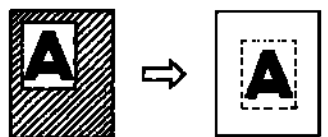
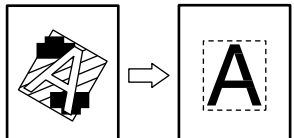
This section provides a description of the image processing features. Procedures on how to use these features can be found in Chapter 3, *Using the Scanner*.

Screen image to Print Image	Description
<p>Auto Masking (1 Frame)</p> 	<p>The black borders along the edges of the image are masked.</p>
<p>Trimming (1 Frame)</p> 	<p>Everything but the center of the image is masked.</p>
<p>Trimming (2 Frames) When 11 x 17" (A3) is selected.</p> 	<p>The frames surrounding the center of both images are masked. The Manual Frame Masking Kit is required.</p>
<p>Masking (1 Frame)</p> 	<p>The center of the image appearing on the screen will be masked. The Manual Masking Kit is required.</p>
<p>Masking (2 Frames) When 11 x 17" (A3) is selected.</p> 	<p>Two areas of the center of the image appearing on the screen will be masked. The Manual Masking Kit is required.</p>
<p>Auto Centering</p> 	<p>An image is generated that is centered on the printed page from the displayed image with a masked frame.</p>
<p>Auto Skew Correction</p> 	<p>Automatically corrects any skew when the image is printed.</p>

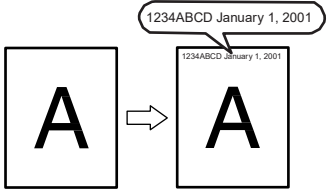
Screen Image to Print Image	Description
<p>Page-by-Page Print</p> 	<p>The system takes two film images that appear side-by-side on the screen and prints them on separate 8 1/2 x 11" (A4) sheets of paper.</p>
<p>Auto Paper Select Print</p> 	<p>The system automatically detects either half-size or full-size film to determine the size of paper for printing (half-size film is printed on 8 1/2 x 11" (A4) portrait paper, full-size film is printing on 11 x 17" (A3) landscape paper).</p>
<p>Imprint</p> 	<p>Time, date and messages can be included on a print. To enable this function, contact your E PM Representative.</p>

3 Using the Scanner

This chapter provides procedures on how to use the IMAGELINK 3000 DV Plus Digital Scanner.

Following is an outline of the basic printing procedure. Detailed procedures on these steps follow in this chapter.

1. Load the film. The procedure for loading film is determined by the type of Film Carrier (optional) that is being used. Review the Operator's Manual that came with your Film Carrier for more information.
2. Select and replace the lens.
3. Position the image to be scanned or printed on the screen.
4. If desired select zoom, focus or rotation options.
5. Select film type and paper size. If both 8 1/2 x 11" (A4) and 11 x17" (A3) are loaded, the system can select the correct size automatically.
6. Select the print position.
7. Select the image density.
8. Enter the number of prints to be made.
9. If necessary, adjust the image processing features.
10. Press **Start** to scan and/or print the displayed image. The scanning and/or printing of the image is initiated after the Start key is pressed.

Selecting a projection lens

Projection lenses are available in the following types. Select the type of lens that corresponds to the film you are using.

- 1 Type 1: 7.5X
- 2 Type 2: 9 to 16X
- 3 Type 3: 13 to 27X
- 4 Type 4: 20 to 50X

The following list shows the standard types of film and the recommended zoom ratios of lenses to be used with the system printer. The size and format of one frame of film may vary depending on the shooting conditions.

Film		Scanning Size			
		11 x 17" (A3)	8 1/2 x 11" (A4)	B4	3 2/3 x 8 1/2"
35mm	Half	2 or 3	2	2	2
	Full	2	1	1	-
16 mm	Half	4	3	3	3 or 4
	Full	3 or 4	2	2	2 or 3
Source Document	60	3 or 4	3	3	3 or 4
	98	4	3 or 4	3 or 4	4
	325	-	4	4	4
	420	-	4	4	-
COM	63	3 or 4	3	3	3 or 4
	70	3 or 4	3	3	3 or 4
	80	4	3 or 4	3 or 4	4
	84	4	3 or 4	3 or 4	4
	120	4	3 or 4	3 or 4	4
	208	4	4	4	4
	270	-	4	4	4

Zoom the lens in and out to find the optimum ratio that will fit the scanning size.

Replacing the projection lens

To replace a lens with a magnification different from the pre-installed lens.

1. Grasp the Prism Holder lever and push it up.

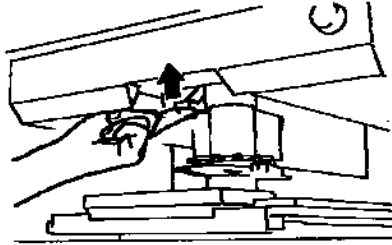

2. Pull out the projection lens unit.

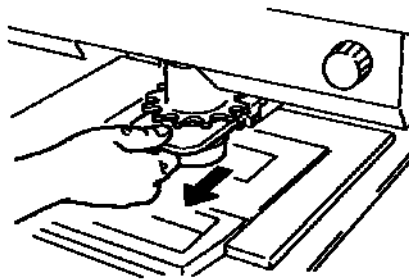

3. Slide the desired projection lens unit into the scanner along the lens holder guide.

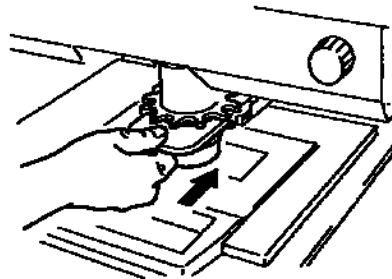

NOTE: When the projection lens unit is slid into position, the scanner automatically selects the optimum screen brightness according to the type of lens being used.

Positioning the film image

The size frame markers that correspond to the scanning size are marked on the screen. Through zooming and image rotation, and by operating the film carrier mounted on the system, position the image on the screen so the image fits in the scanning size.

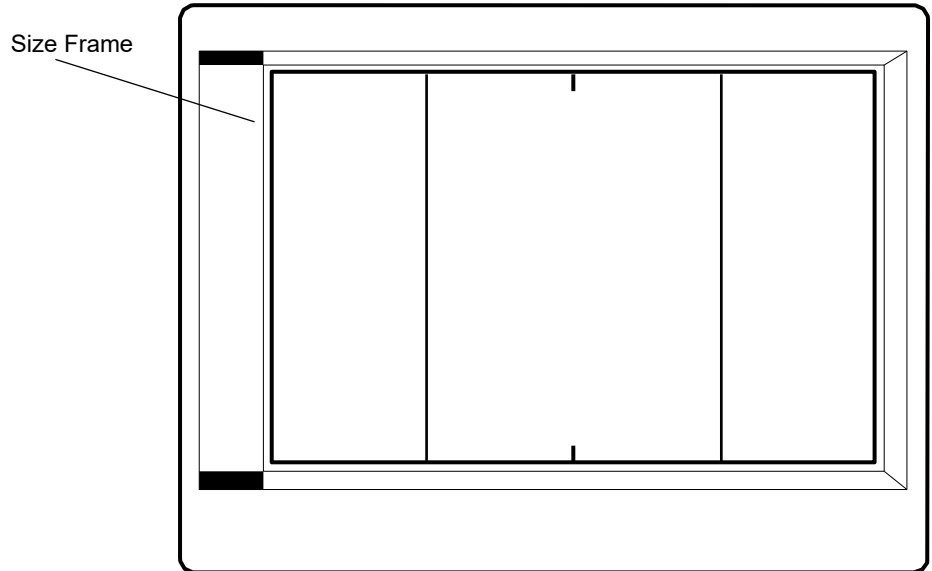

11 x 17" or A3 size	8 1/2 x 14" size
<p>A vertical frame with the word 'DIGITAL' written vertically on the left side. To the right of the text are two white squares stacked vertically. The frame has a thin border.</p>	<p>A horizontal frame with the word 'DIGITAL' written vertically on the left side. To the right of the text are two white squares stacked vertically. The frame has a thin border.</p>
8 1/2 x 11" or A4 size	
<p>Vertical</p> <p>A vertical frame with the word 'DIGITAL' written horizontally at the top left. Below the text are two white squares stacked vertically. The frame has a thin border.</p>	<p>Horizontal</p> <p>A horizontal frame with two white squares stacked vertically on the left side. The frame has a thin border.</p>

Zooming, focusing and image rotation

Zooming in on the displayed image:

- Turn the Zooming Ring dial (blue) to bring the image on the screen into the print size frame.

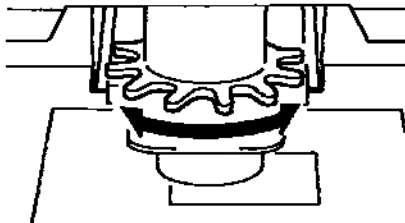

Focusing the displayed image:

- Center the displayed image and press the AF (Auto Focus) key to let the scanner automatically bring the image into focus.

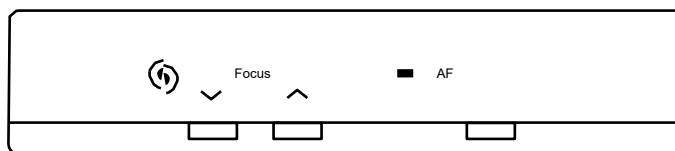

NOTE: You can use the Focus (manual focus) keys to manually adjust the focus of the displayed image.

Image rotation

- Turn the Image Rotation knob until the image is displayed at the desired rotation or to correct the skew of the image.

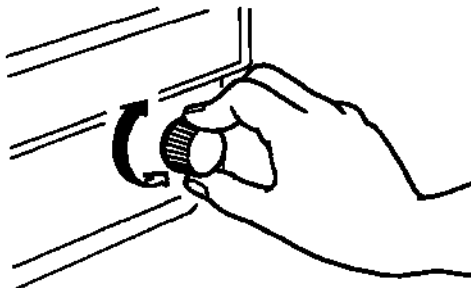

NOTES:

- If you hold down the Shift key and turn the Image Rotation knob, the image quickly rotates by 90 degrees.
- If Auto Skew Correction is turned on, the system automatically corrects any skew of the image when printed. When Auto Skew Correction is on, the indicator is lit.

Selecting the film type

Auto

The system will automatically determine the polarity of the film being used when **Auto** is selected.

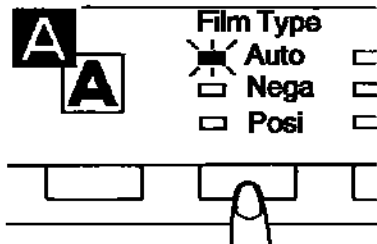

NOTE: The system cannot determine the polarity of certain types of film. If the system cannot detect a film type, select it manually. The system does not detect exterior conditions such as when the glass surface of the carrier is dirty or scratched.

Nega (Negative film)

If negative film is being used, press the Film Type key to select **Nega**.

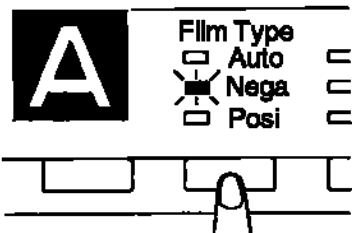

Posi (Positive film)

If positive film is being used, press the Film Type key to select **Posi**.

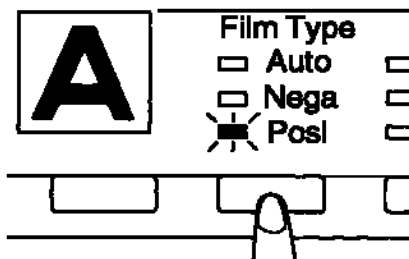

Selecting the paper size

Press the **Paper Selection** key to select the desired print size. The system cycles through the available sizes each time you press the key.

NOTE: If the printer is not loaded with a desired size paper, load the paper into the printer.

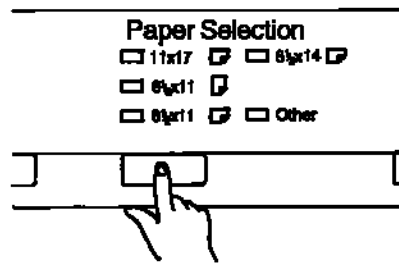

Using the Auto Paper Selection function

When the paper feeding tray is loaded with 8 1/2 x 11" (A4) paper and the paper cassette is loaded with 11 x 17" (A3) paper, this function can be used to automatically select the appropriate size of paper for the current job.

- Press the **Paper Selection** key so both the 11 x 17" (A3) and the 8 1/2 x 11" (A4) LEDs light up.

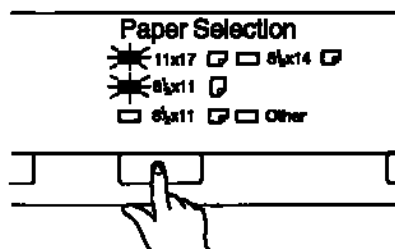

The system automatically detects the image area and prints on 8 1/2 x 11" (A4) paper for half-size film and on 11 x 17" (A3) paper for full-size film.

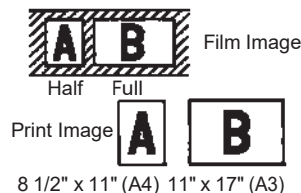

NOTES:

- The Auto Paper Selection function can only be used for a combination of 11 x 17" (A3) and 8 1/2 x 11" (A4) paper sizes. The Page-by-Page function cannot be selected when the Auto Paper Selection capability is being used.
- When a 7.5x or 7.7x lens is being used, the Auto Paper Selection function cannot use 11 x 17" (A3) size paper because of the size of the image area.
- When **Masking** or **Trimming** has been selected, the system selects 8 1/2 x 11" (A4) if the defined area is less than 8 1/2 x 11" (A4) size and 11 x 17" (A3) for all other print jobs.

Using the Auto Film Format Selection function

When the paper feeding tray and paper cassette is loaded with 8 1/2 x 11" (A4) paper, this function can be used to automatically select the appropriate size of paper for the current print job.

1. Press the **Paper Selection** key so both the 8 1/2 x 11" (A4) and the 8 1/2 x 11" (A4) LEDs light up.

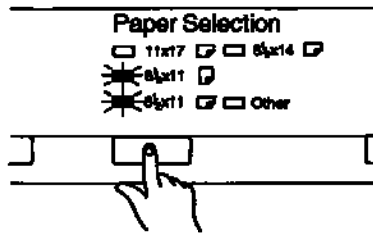

2. Press the **Start** key. The system automatically detects the image area and prints on 8 1/2 x 11" (A4) paper for portrait film and on 8 1/2 x 11" (A4) paper for landscape film.

Portrait

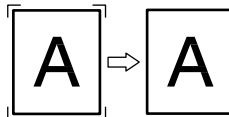

Landscape

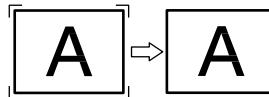

Selecting the Print Position

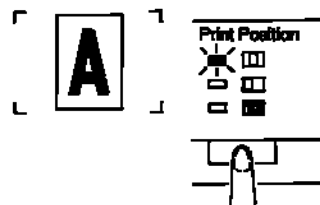

Center

- The system prints the image that appears in the center of the screen.

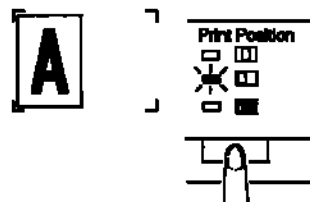

Left

- The system makes a print of the image that appears on the left side of the screen.

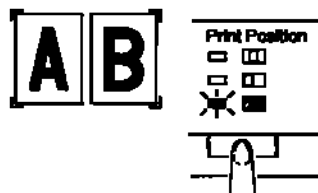

Page-by-Page

- The system prints the images that appear on both the left and right sides of the screen on separate sheets of 8 1/2 x 11" (A4) paper.

NOTE: Only 8 1/2 x 11" (A4) paper can be selected for Page-by-Page.

Selecting the image density

Using Auto Exposure

1. Press the **Exposure Mode** key to select the Auto Exposure mode.

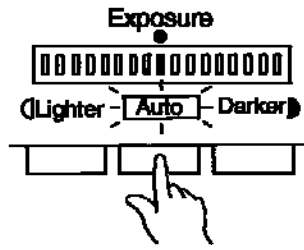

2. If the Auto Exposure setting is not satisfactory, press the appropriate Exposure Adjustment key, either **Lighter** or **Darker**, to set the desired image density.

Using Manual Exposure

1. Press the **Exposure Mode** key and select the Manual Exposure mode.

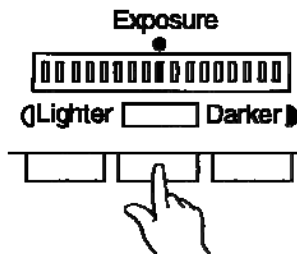

2. Press the appropriate Exposure Adjustment key, either **Lighter** or **Darker**, to set the desired image density.

Entering the number of prints to be made

This function is only available in PR mode.

Entering a number from 1-9

- Enter the desired number of prints using the Multi Print key “1”.

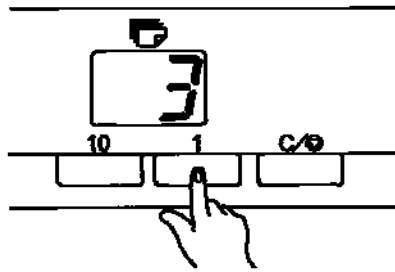

If the **1** key is pressed when **9** is displayed, the number on the display is incremented by one: 10, 11, 12, etc.

Entering a number from 10-99

1. Set the tens digit using the **10** key.
2. Set the units digit using the **1** key.

For example, to set “25” press the **10** key twice and press the **1** key four times.

Correcting a number

To reset an entry:

- Press the **Clear/Stop** key, which resets the number on the Multi-Print display to “1”.

Adjusting Image Processing features

Using Auto Masking

The Auto Masking function prevents the frame (non-image area) of a film image from appearing on the print.

- Press the **Auto Masking** key to turn on this function.

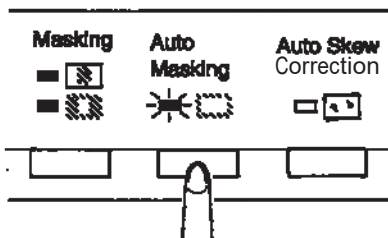

NOTES:

- The image area of the screen must provide at least 45 mm horizontally and vertically.
- The width of the frame to be masked must be at least 10 mm.

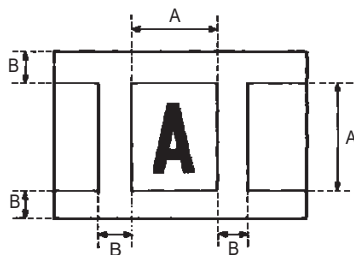

- If the film image on the screen does not meet the above requirements, the Auto Masking function will not work properly. Auto Masking is a frame erasing feature, it cannot remove an image from in between two separate frames.

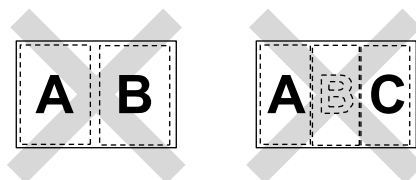

Manual Masking panels (option)

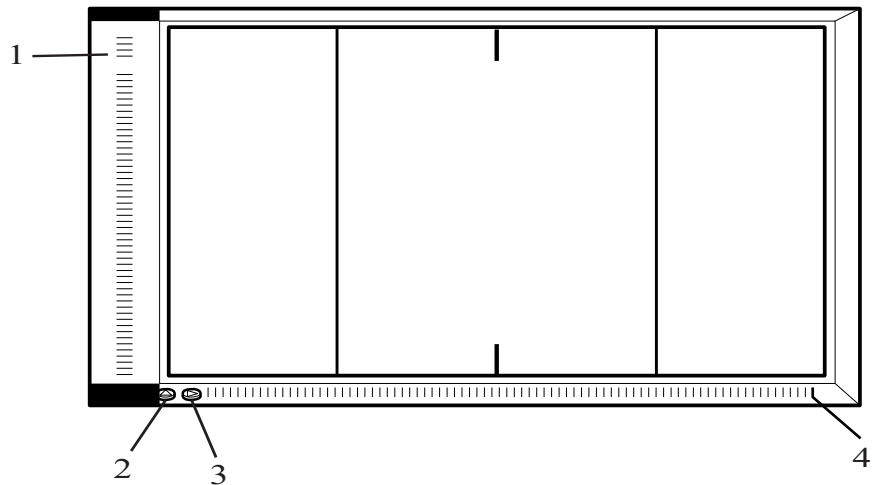

- 1 Lengthwise Area Indication panel** — use to specify the print area in the vertical direction of the image on the screen. The system makes a print of the image corresponding to the way the Area keys are illuminated. A total of 42 Area keys are placed at 7 mm intervals.
- 2 Lengthwise Area Clear key** — press to clear any print area previously defined in the vertical direction.
- 3 Crosswise Area Clear key** — press to clear any print area previously defined in the horizontal direction.
- 4 Crosswise Area Indication panel** — use to specify the print area in the horizontal direction of the image on the screen. The system makes a print of the image corresponding to the way the Area keys are illuminated. A total of 61 Area keys are placed at 7 mm intervals.

NOTE: When 11 x 17" (A3) and Page-by-Page are selected, all keys light up except those on the right and left ends. The keys on the right and left ends are invalid for the Manual Masking panels intended for use in the metric areas.

Using Manual Masking

NOTES:

- Under the PC mode, the print (scan) area can be defined using the Manual Masking panels.
- The Trimming and Masking functions cannot be used in the PC mode.

The optional Manual Masking Kit allows you to specify an area of printing of the displayed image through two separate features: trimming and masking.

Selecting Trimming

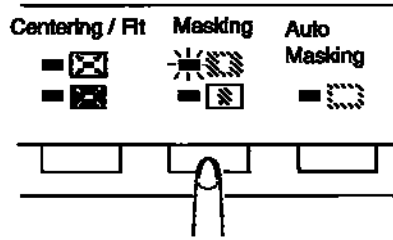

- Press the **Masking** key to select **Trimming**. The lights on the panel light up according to the currently selected paper size and print position.

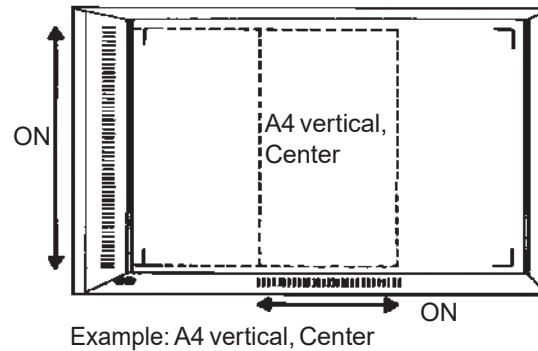

NOTE: You can print the area specified by the green lights. The lights which do not match with the selected paper size and the print position may light up just after the Job Program is called.

Defining an area

Define the end points for both the vertical and horizontal areas of the image on the screen using the green lights on the area indication panels.

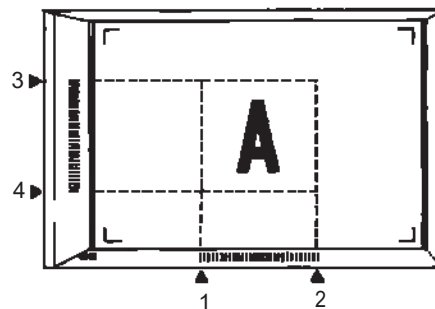

NOTE: The points defining the vertical and horizontal area can be selected in any order. Blinking lights on the indication panels indicate an improper entry of the specified area.

Defining two separate areas

- Define the areas to print by specifying the vertical and horizontal areas as follows: 2 end points for vertical and 4 end points for horizontal.

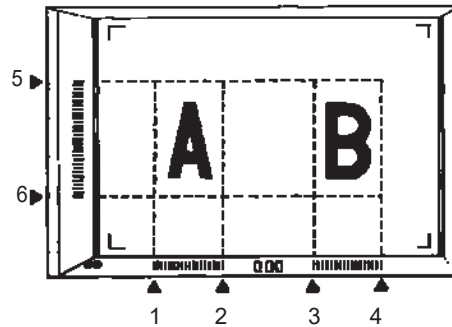

NOTE: The points defining the vertical and horizontal area can be selected in any order. Blinking lights on the indication panels indicate an improper entry of the specified area.

Defining Page-by-Page print area

- Using the vertical and horizontal points on the Area indication panels, define the print areas of the image on the screen.

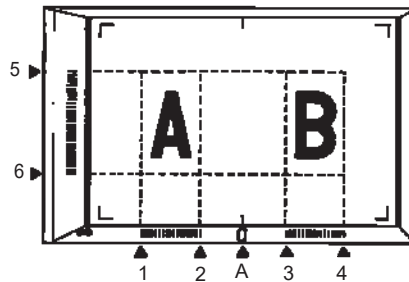

NOTES:

- The horizontal indicator marked **A** does not light up and cannot be used for defining an area.
- Four different areas cannot be defined on a single page.
- If the Area keys start blinking when the Print key is pressed, it indicates that the print area defined is not available. Specify the area again.
- Paper must be 11 x 17" (A3) when defining two areas and 8 1/2 x 11" (A4) when defining Page-by-Page print areas.
- Paper can be any size when defining one area.
- The print area, once defined, is stored in memory for each paper size and print position. Press the **Area Clear** key to clear the area setting.

Clearing a defined print area

- Press the **Vertical** and **Horizontal Clear** keys.

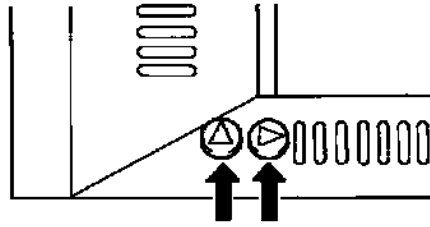







Selecting Masking

- Press the **Masking** key to select Masking when you want to mask a specific area of an image.

NOTE: The basic operation for Manual Masking is similar to Trimming. Refer to the previous procedures on Trimming and defining areas for Manual Masking procedures.

Using Centering and Fit

Once the image on the screen has been manually trimmed or auto masked, the Image Centering function moves the image to the center of the print. The Fit function however, fits the image on the screen onto the entire surface of the print.

	Screen Image	Print Image	
Centering		Centering Off	Centering On
			
Fit		Fit Off	Fit On
			

Centering

- Press the **Centering/Fit** key to turn on Centering.

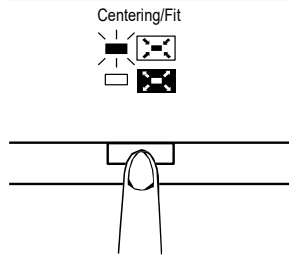

NOTE: Centering/Fit mode cannot be used if Masking is selected.

Fit

- Press the **Centering/Fit** key to turn on Fit.

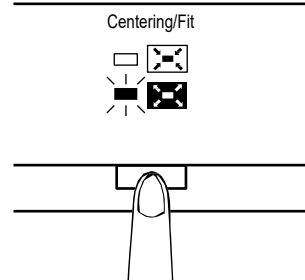

NOTE: Fit mode cannot be used when the scanner is connected to the PC.

Using the Cycle Print mode

This function automatically scans the next image following a preset period of time. Images are manually loaded on the carrier glass in between cycles.

Cycle Print mode is a system setting that must be entered by an Service Representative.

This function is only available in the PR mode.

Specifying the interval between scanning operations

The chart below provides the time intervals that can be set between scanning operations. The time interval is based upon how much time it takes you to move, for example, a roll of film from frame-to-frame. Refer to this table when making a value selection.

Value	1	2	3	4	5	6	7	8	9	0
Period (seconds)	0.5	1.0	1.5	2.0	2.5	3.0	3.5	4.0	4.5	5.0

1. Press the **10** key to change the value to **A**. This enables the Cycle Print mode.
2. Press the **1** key to change values. Each value corresponds to an interval between scanning operations shown in the table above.
3. Press the **Memory Input** key to store the currently selected interval setting of the Cycle Print mode into the memory.

Operating in the Cycle Print mode

- After entering the Cycle Print mode, press the **Start** key. After the first scanning operation has finished, the system will automatically scan the next image following a preset period of time. The system will continue to operate until the Cycle Print mode is canceled.

The *No. of Copies* value flashes during the scanning and waiting operations.

The next scanning job can be started manually by pressing the **Start** key before the system automatically initiates the same job.

To pause an operation during the Cycle Print mode:

- Press the **Clear/Stop** key (the *No. of Copies* value switches from a flashing display to a constant display).

While the Pause function is enabled, it is possible to exit the Cycle Print mode by pressing the **Clear/Stop** key a second time (the value displayed in the *No. of Copies* display will change to a 1).

Selecting the Connection mode

The scanner connection can be selected between **PR** (connection to the printer) and **PC** (connection to the personal computer).

- Press the **Shift** key and the **PC/PR** key together for over one second.

PC mode — when the display is switched from Multi-Print to PC, the connection to the PC is valid.

PR mode — when the display is switched from PC to Multi-Print, the connection to the Printer is valid.

Selecting the Resolution

1. Press the **Shift** key and the **Resolution** key together. The current resolution is displayed.

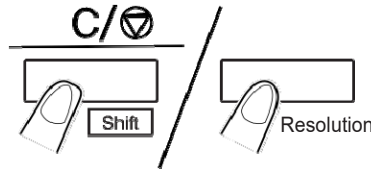

2. Press the **Resolution** key while holding down the **Shift** key to set the resolution.

Connection mode	Resolution	Display
PR mode	400 dpi	4H
	600 dpi	6H
PC mode	200 dpi	2H
	300 dpi	3H
	400 dpi	4H
	600 dpi	6H
	800 dpi	8H

NOTE: 800 dpi can only be selected when the vertical length of the scan image on the screen is less than 220 mm.

Registering the Job Program

The current setting can be set up to 3 program registration locations (1J, 2J and 3J) for both the PR connection and the PC connection. Once the Job Programs have been set, you can recall them as needed.

1. Press the **Memory Input** key in the Setting mode. 1J starts blinking.

To change the program registration location, press the **1** key. The display is cycled in order of 1J to 2J to 3J to 1J.

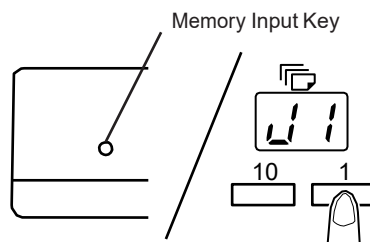

2. Select the program registration location (1J, 2J or 3J), and press the **Memory Input** key again.

The program registration is over when all LEDs on the control panel light up and the normal display is resumed.

Calling the Job Program

To call a registered Job Program:

1. Press the **Shift** key and the **Job Recall** key together.

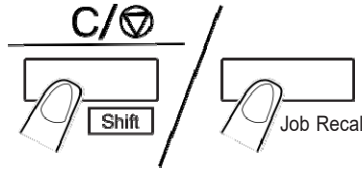

Each time the Job Recall key is pressed while the Shift key is held down, the display is cycled in order of 1J to 2J to 3J.

When the desired setting is displayed, release the keys.

Using Electronic Zoom

In addition to using the lens to zoom, the electrical zoom function has been provided for magnifying the image when it is printed. *This function is only available in PR mode.*

Zoom+: when the **Zoom+** key is pressed with the **Shift** key, the magnification is increased by an increment of 0.01X (up to 2.00X).

Zoom-: when the **Zoom-** key is pressed with the **Shift** key, the magnification is decreased by a decrement of 0.01X (down to 0.50X).

NOTES:

- The Zoom magnification is displayed in the Multi-Print display to 3 decimal places.
- The Zoom magnification level is displayed in the Exposure display. For example, when the magnification is 0.50X, it is displayed as 50. When the magnification is 1.50X, it is displayed as 150.
- When the Zoom magnification is changed, the display is made in the Multi-Print display as follows.



- When it is returned to the standard magnification, this display goes off.
- When the Zoom function is used, Multi-Print can be set up to 9.

Skip magnification

Hold down the **10** key and the **Zoom+** or **Zoom-** key together, the magnification skips as follows:

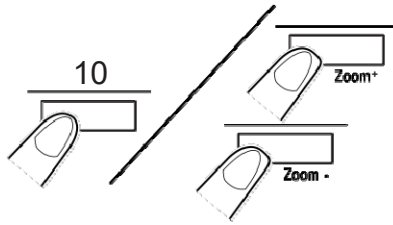

Inch Area		Metric Area	
Magnification	Size	Magnification	Size
0.50	minimum	0.50	minimum
0.65	11 x 17" to 8 1/2 x 11"	0.71	A3 to A4
0.77	11 x 17" to 8 1/2 x 11"	0.82	B4 to A4
0.79	8 1/2 x 14" to 8 1/2 x 11"	0.86	A3 to B4
1.00	full	1.00	full
1.27	8 1/2 x 11" to 8 1/2 x 14"	1.15	B4 to A3
1.29	8 1/2 x 11" to 11 x 17"	1.22	A4 to B4
1.55	8 1/2 x 11" to 11 x 17"	1.41	A4 to A3
2.00	maximum	2.00	maximum

Clearing the Zoom magnification

When the **Zoom clr** key is held down with the **Shift** key for more than one second, the standard magnification (1.00x) is resumed.

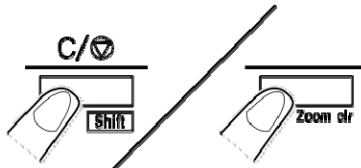

Adjusting screen illumination

- Press the **Illumination** key to adjust the illumination of the screen.

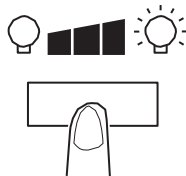

The screen is gradually darkened until it is turned off. When any key is pressed, the illumination returns to the maximum level.

When the illuminance of the screen is dark, hold down the **Shift** key and the **Illumination** key together. The illuminance of the screen is gradually lightened until the maximum level is achieved.

4 Printer Functions

This chapter provides information on how to use and maintain your 34 ppm High Speed Video Laser Printer.

Printer components

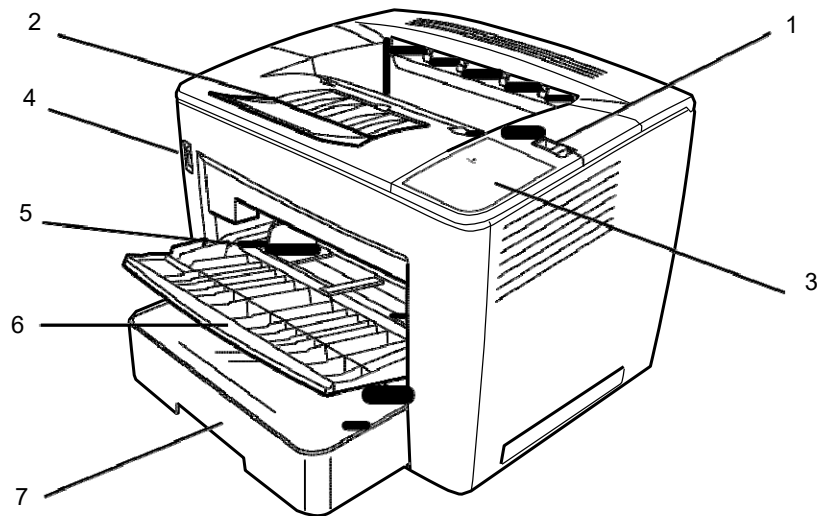

- 1 Top cover release lever** — used to open the top cover.
- 2 Output tray extension** — fold open when printing on B4 paper larger.
- 3 Power indicator** — lights when the printer is turned on.
- 3 Power switch** — use to turn the printer on and off.
- 4 Paper guides** — slide the guides to secure the paper stack.
- 5 Paper feeding tray** — capable of holding up to 200 sheets of standard paper ranging from 8 1/2 x 11" (A4) to 11 x 17" (A3).
- 6 Paper cassette** — capable of holding up to 500 sheets of standard-sized paper: 5 1/2 x 8 1/2" (B5) to 11 x 17" (A3).

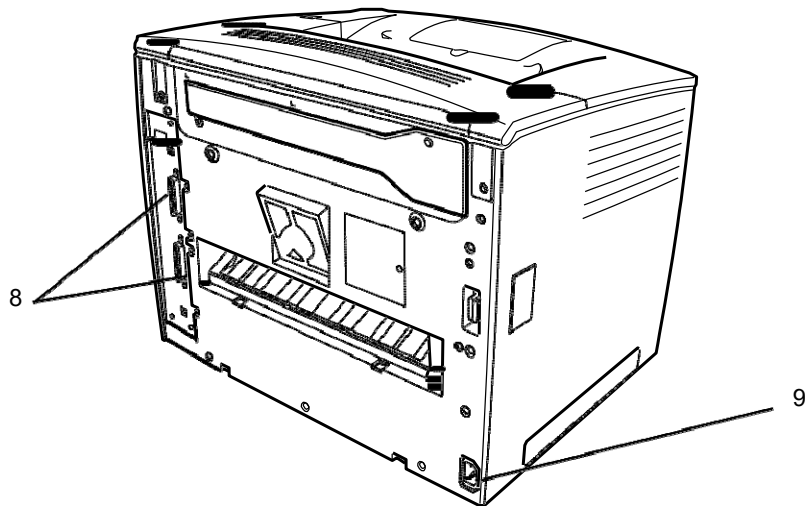

8 Interface connectors — these two connectors allow the connection with separate scanner units.

9 Power cord socket — plug the power cord into this socket.

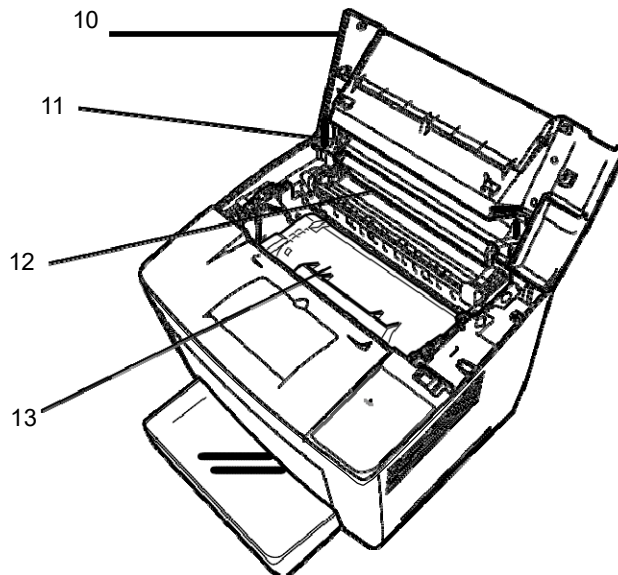

9 Top cover — open to replace the toner cartridge and to clear misfed sheets of paper.

10 Image transfer roller — transfers the image onto a sheet of paper. Do not touch this roller with your bare hands.

11 Fusing unit — permanently fixes the image onto the sheet of paper.

13 Toner cartridge — where the image is generated for transfer onto a sheet of paper. Do not touch it with your bare hands.

Paper specifications

Use only the following types of paper:

Type — plain and recycled paper (weight 16 to 24 lbs / 60 to 90 g/m²)

Standard sizes — 11 x 17", 8 1/2 x 11", 8 1/2 x 14", A3 and A4.

Capacity

- **Paper Feeding Tray:** 8 1/2" x 11", 11" x 8 1/2", 8 1/2" x 14", 11" x 17" (or A3, A4) plain and recycled paper - up to 250 sheets.
- **Paper Cassette:** 11" x 8 1/2" 8 1/2" x 14", 11" x 17" (or A3, A4) plain and recycled paper - up to 500 sheets.

Loading paper into the paper feeding tray

1. Open the paper feeding tray.

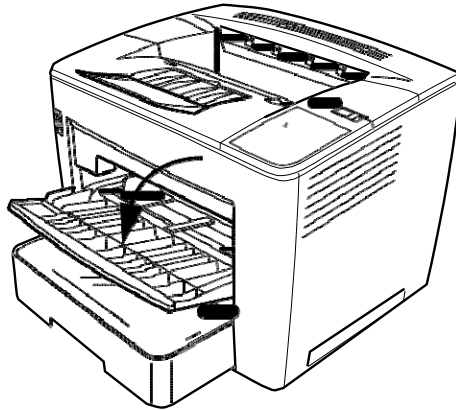

2. Fan a paper stack of paper.

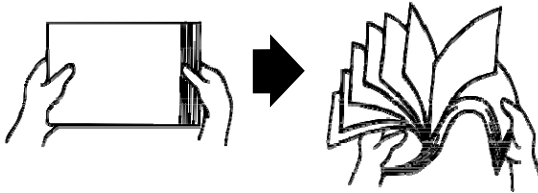

3. Align the edges of the paper and load it with the printing side up. Do not load paper above the fill limit mark on the inside left of the tray.

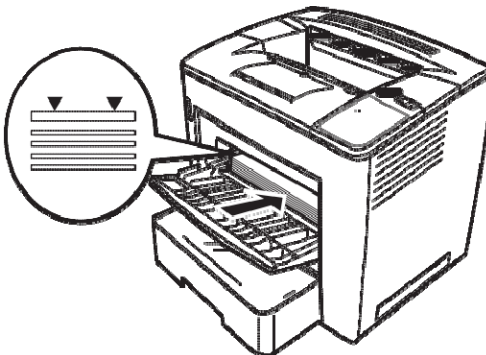

4. While pressing the button on the right side of the media guide, slide the media guide to adjust it.

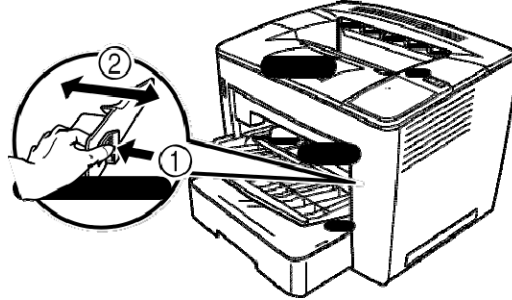

NOTE: Make sure the paper fit easily between the guides. Improperly adjusted guides may cause poor print quality, paper jams, or printer damage.

Loading paper in the paper cassette

1. Pull out the paper cassette until it stops.
2. While pressing the release buttons (one on each side), remove the paper cassette.

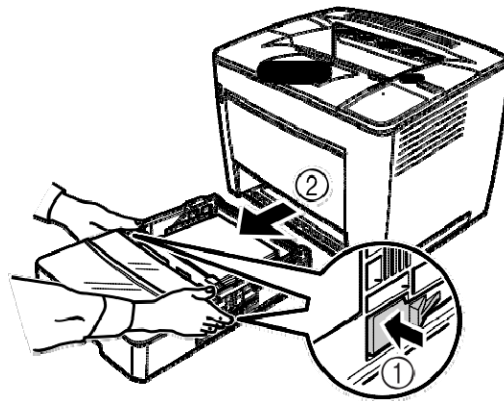

3. Remove the cassette cover.

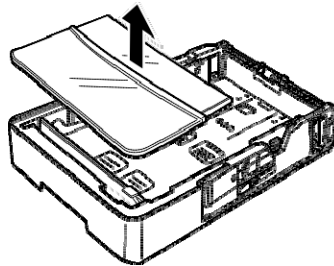

4. Lift up the gray lever on the right end of the paper retainer, and slide the paper retainer to the right.

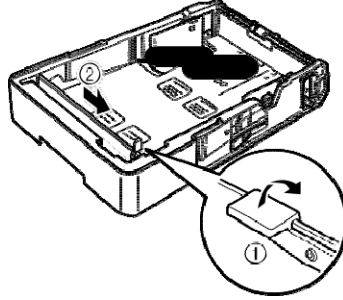

5. Lift up on the left end of the paper retainer to remove it.

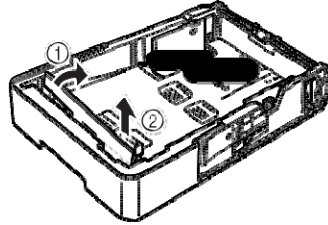

6. Insert the right end of the paper retainer into the slot for the size of paper to be loaded.

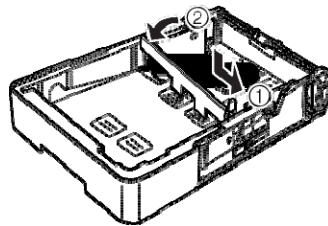

NOTE: The paper size detected depending on the position of the paper retainer. Correctly position the paper retainer according to the size of paper to be loaded.

7. Slide the paper retainer to the left, and press down on the gray lever to secure the paper retainer. Make sure the paper retainer is seated properly.

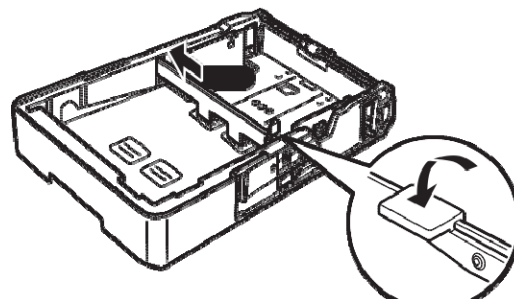

8. Align the four edges of the paper, and then load the paper printing side up.

Do not load paper on this side.

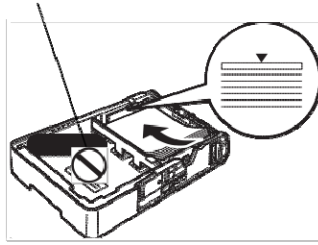

Long-edge Feed Examples

Letter, A4 and B5

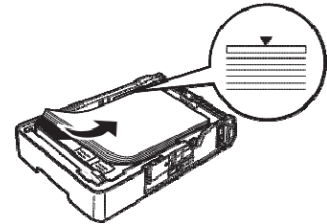

Short-edge Feed Examples

Ledger, Legal, A3 and B4

NOTE: A maximum of 500 sheets (20 lb. bond [75 g/m²] plain paper) can be loaded. If paper is loaded past the triangular mark, it may not be fed correctly.

9. Press in the button on the paper guide, and then slide the guide against the edge of the paper.

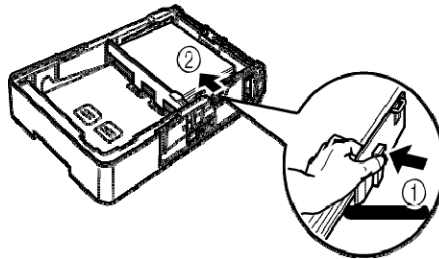

NOTE: The paper should fit easily between the guides. Improperly adjusted guides may cause poor print quality, paper jams, or printer damage.

10. Install the cassette cover.

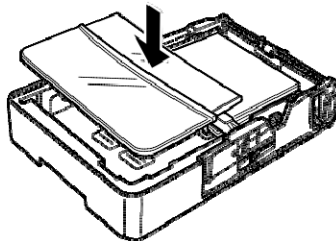

11. Slide the paper cassette into the printer.

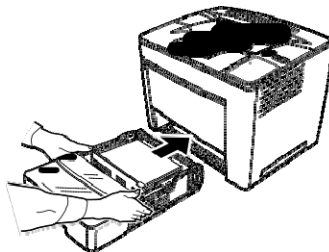

12. When printing on paper B4 or larger, fold open the output tray extension.

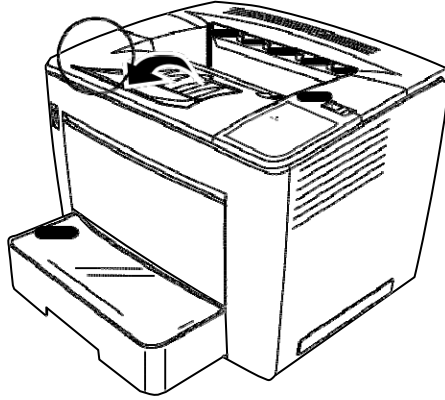

13. Affix the paper size labels (supplied with the printer) to the paper cassette in order to indicate the size of loaded paper.

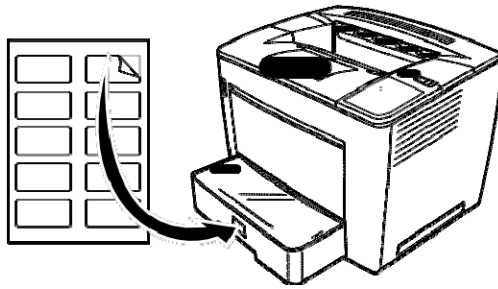

Replacing the toner cartridge

1. Slide the top cover release lever to the right, and open the top cover

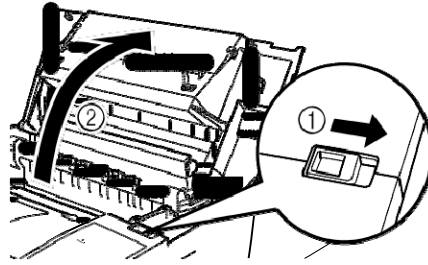

NOTES:

- Never touch the copper or brass electrodes or electrical parts that are located inside the top cover and underneath the toner cartridge, as a printer malfunction can result.
- Be careful not to touch around the image transfer roller (touching certain parts in this area may result in reduced print quality) or around the fusing unit (since the inside reaches temperatures of about 392 °F (200 °C), touching any part in this area may result in burns).

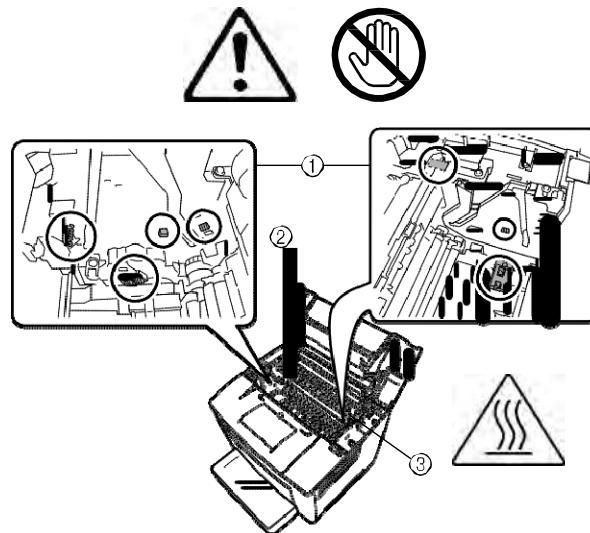

2. Remove the used toner cartridge.

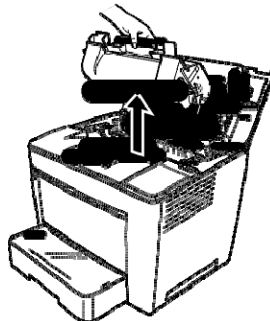

3. Remove the new toner cartridge from its protective box.

4. Peel off the packing tape.

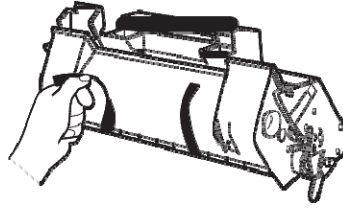

NOTE: Hold the toner cartridge by its handle. Do not open the protective cover of the OPC (the green area) or allow anything to come in contact with the OPC. It is extremely sensitive to hand oils and scratches, both of which reduce print quality. This type of damage is not covered by your warranty.

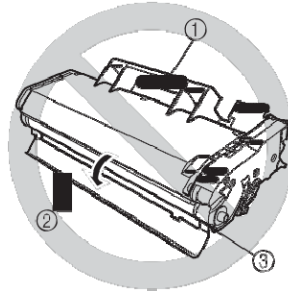

5. Slowly shake the toner cartridge, tilting it to the left and right 7 or 8 times to distribute the toner.

The toner is nontoxic. If you get toner on your hands, wash them in cool water and mild neutral detergent. If you get toner on your clothes, lightly dust them off as much as possible. If some toner remains on your clothes, use cool, not hot, water to rinse the toner off, provided your clothing is washable.

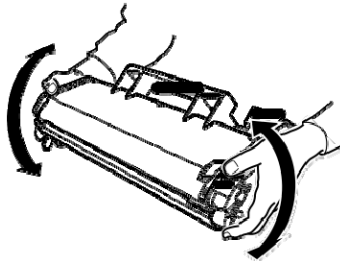

WARNING: If you get toner in your eyes, wash it out immediately with cool water and consult a doctor.

6. Align the tabs on the cartridge (one on each side) with the notches in the printer, and then insert the cartridge as far as possible into its compartment

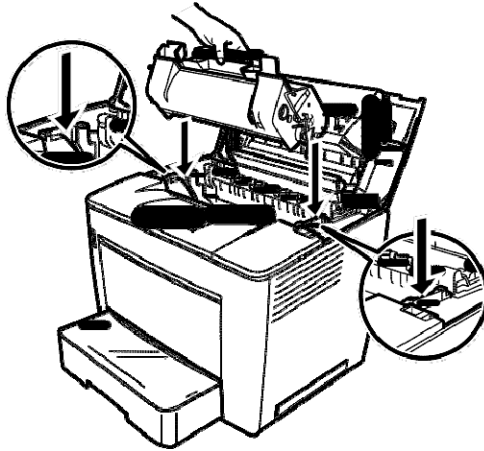

7. Close the top cover, pushing it down until it locks into place.

NOTES:

- Do not transport the printer with the toner cartridge installed. If toner spills within the printer, decreased print quality may result or the printer may be damaged.
- Guidelines are available for disposal of toner cartridges that are replaced during maintenance or service. Follow local regulations.

Replacing the exhaust filter

Replace the exhaust filter on the back of the printer when you replace the toner cartridge.

1. Remove the used exhaust filter and dispose of it according to your local regulations.

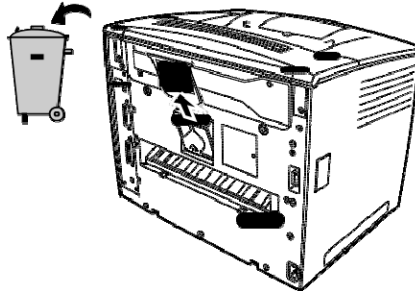

2. Remove the new filter from its box and insert it into place.

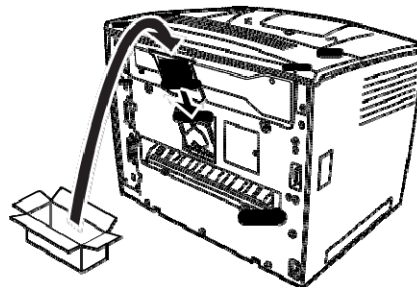

Troubleshooting

Misfeed clearing procedure

Locate the misfeed using the code and perform the misfeed clearing procedure.

CAUTION: The fusing unit inside the printer becomes very hot during operation. To avoid a burn, be very careful not to touch it.

Display	Code	Description
	P0	The wrong size paper has been loaded in the paper feeding tray. <ul style="list-style-type: none">• Load the set size paper in the set direction. This code also appears when two or more sheets of paper are taken up at the same time.
	P1	There is a misfeed near the paper take-up section or more than one sheet of paper is taken up at the same time.
	P2	There is a misfeed near the toner cartridge.
	P3	There is a misfeed near the fusing unit.

Clearing a misfeed from the paper feeding tray

1. Remove all paper from the paper feeding tray.
2. Pull out the misfed paper.
3. Correctly load the paper into the paper feeding tray.
4. If necessary, open and close the top cover to cancel the misfeed code.

Clearing a misfeed from the paper cassette

1. Pull out the paper cassette until it stops.
2. While pressing the release buttons (one on each side) remove the cassette.
3. Pull out the misfed paper. Make sure no paper remains under the roller in the cassette.
4. If the misfeed paper cannot easily be pulled out, lift the green lever on the inner-right side to release the paper feed roller, and then pull out the paper. After removing the misfed paper, be sure to return the green lever to its original position. Do not use force to remove jammed paper.
5. Before reinstalling the cassette, check that the paper remaining in the cassette is loaded correctly. Make sure no paper remains misfeed under the roller in the cassette.
6. Reinstall the cassette.

Clearing a misfeed from inside the printer

1. Open the top cover.

CAUTION: Never touch the copper or brass electrodes or electrical parts that are located inside the top cover and underneath the toner cartridge, as a printer malfunction can result.

Do not touch around the image transfer roller (may result in reduced print quality) or around the fusing unit (may result in burns).

2. Remove the toner cartridge and store it in a light-free protective bag.
3. If the paper is stopped by the fuser, lift the green levers on each side and slowly pull out the paper from the roller.

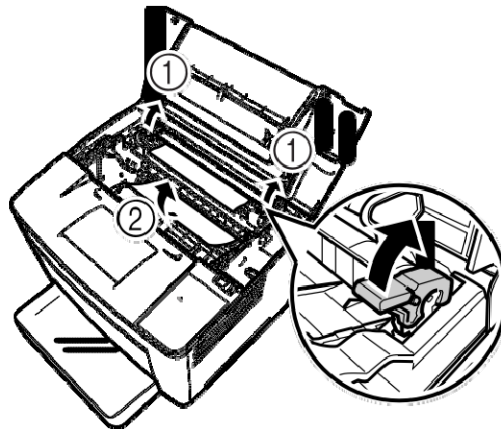

NOTE: Do not pull out the paper from above the rollers; otherwise decreased print quality may result.

4. After removing the misfed paper, lower the two levers.
5. Open the paper feed roller cover.

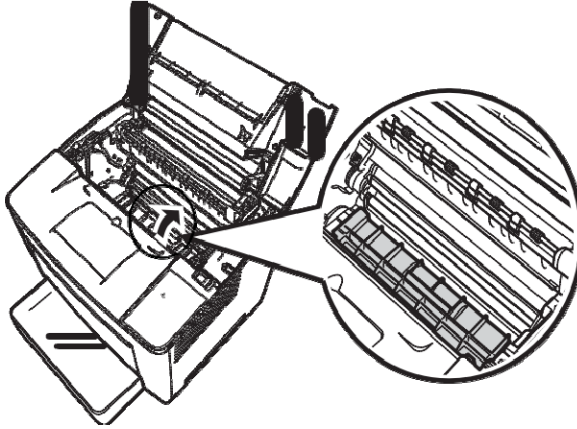

6. Pull out the jammed paper.
7. Close the paper feed roller cover.
8. Align the tabs on the toner cartridge with the notches in the printer and insert the cartridge.

NOTE: Do not touch the rollers or gears within the printer.

9. Close the top cover.

Printer maintenance

Clean the printer at regular intervals.

NOTES:

- Use a soft cloth and NEVER use abrasives or corrosive detergents; a damp cloth and a mild home detergent can be used for heavier cleaning.
- Never spray cleaning solution directly on the printer's surface; the spray could penetrate the air vents and damage the printer.
- Do not spill water or detergent into the printer.
- Never touch the copper or brass electrodes or electrical parts that are located inside the top cover and underneath the toner cartridge, as a printer malfunction can result.
- Do not touch around the image transfer roller (may result in reduced print quality) or around the fusing unit (may result in burns).

1. Before cleaning the printer, turn off the power, unplug the power cord and disconnect all interface cables.
2. Clean the exterior panels with a soft, dry cloth.
3. Open the top cover.
4. Remove the toner cartridge and store it in a light-tight protected bag.
5. Open the paper feed roller cover.
6. Wipe the paper feed rollers with a soft, dry cloth.
7. Close the paper feed roller cover.
8. Reinstall the toner cartridge and close the top cover.
9. Turn the printer on.

Cleaning the paper cassette pickup rollers

1. Pull the paper cassette out of the printer and remove it.
2. Wipe the pickup roller with a soft, dry cloth.

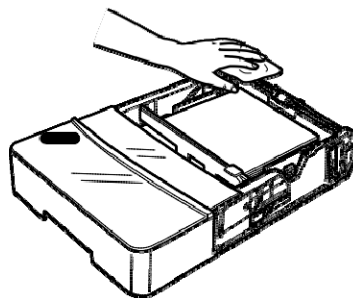

3. Reinsert the paper cassette into the printer.

5 Maintenance

This chapter provides maintenance procedures for cleaning the scanner and replacing the projection lamp.

Cleaning the scanner

The scanner should be cleaned daily for optimal operating conditions.

Cleaning the scanner screen

- With a damp cloth, clean and remove any dust or debris from the surface of the screen.

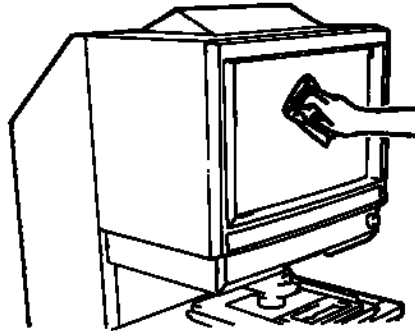

CAUTION: Never use alcohol or any other solvent when cleaning to avoid causing damage to the screen or erasing the frame size markers.

Outer covers

- Dust the exterior panels of the scanner with a soft, dry cloth.

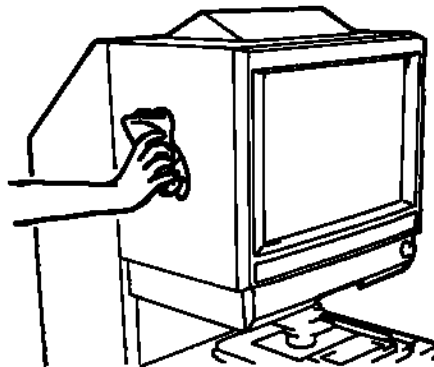

Carrier Glass (option)

NOTE: Before cleaning the carrier glass, remove the projection lens from the scanner. Refer to Chapter 3, "Installing the projection lens" for procedures.

- With a damp cloth, clean and remove any dust or debris from the surface of the carrier glass.

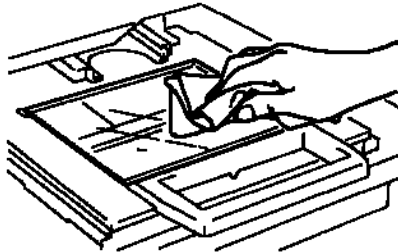

To open the carrier glass:

- Pull the handle of the microfiche holder. With a damp cloth, clean and remove dust and debris by wiping the inner surfaces of the carrier glass.

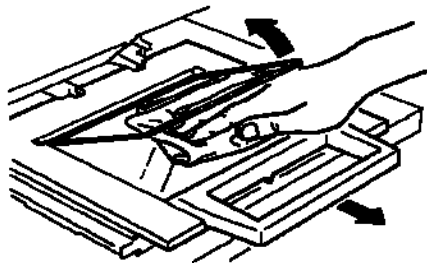

Replacing the projection lamp

Use the following procedure to replace the projection lamp whenever a reduction in brightness on the screen is detected or whenever the lamp burns out. Make sure that the replacement lamp is specified for use with this scanner.

If the projection lamp burns out during a print operation, an L2 code appears and the print job will stop (a blank piece of paper may be output depending upon the stage of the job).

Once the system detects that the projection lamp has burnt out, the scan job will be cancelled. If the system is operating in the Cycle Print mode, the scanner operation will stop.

1. Turn the power switch off.

WARNING: Never touch the lamp with bare hands just after operation or immediately after turning it off. Wait at least 10 minutes after shutting the power off to allow the lamp to cool down as it becomes very hot during use.

2. Slide out the projection lamp unit.

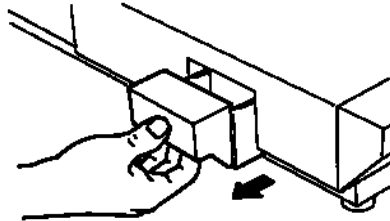

3. Remove the projection lamp, together with the lamp socket, from the project lamp unit.

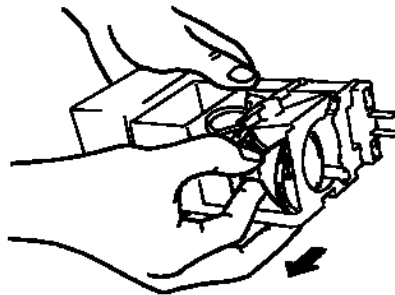

4. Unplug the projection lamp from the lamp socket.

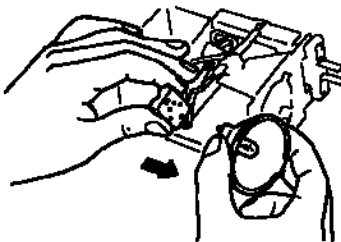

5. Insert the new projection lamp so that the mark on its base is facing upwards. Make sure that the new projection lamp is inserted securely so there is no gap between the projection lamp and the lamp socket.

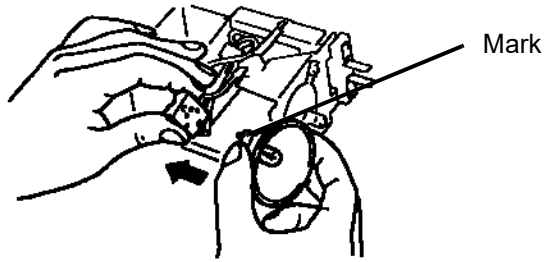

CAUTION: Do not touch the reflector mirror surface of the projection lamp. Fingerprints, smudges or debris should be wiped clean with a soft, dry cloth.

6. Insert the projection lamp all the way into the lamp holder of the projection lamp unit.

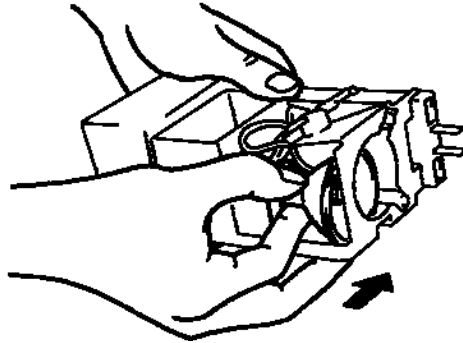

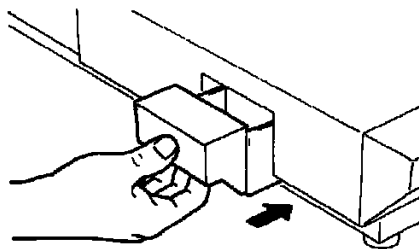

7. Slide the projection lamp unit securely back into place.



6 Troubleshooting/Messages

This chapter contains information on analyzing and correcting operating problems or errors that may occasionally arise during the use of the IMAGELINK 3000 DV Plus Digital Scanner.

Printer /Scanner malfunctions

Display	Code	Description
---	E1	Power to the printer is off or there is a problem with the connection of the interface cable to the printer. Turn on the printer or make sure that the interface cable is securely connected.
	E2	The upper cover of the printer is not closed. Make sure that it is completely closed.
---	E3	The toner cartridge is not installed or is defective. <ul style="list-style-type: none"> • Install a correct toner cartridge.
	E4	A different type of toner cartridge is set. <ul style="list-style-type: none"> • Install a correct toner cartridge.
	Γ E	You are using an end-of-life (completely used) toner cartridge. When the Start key is pressed again it prints. (When Clear/Stop key is pressed, the print is cancelled.) <ul style="list-style-type: none"> • Replace the toner cartridge immediately.
	PE	Paper Empty indicator: lights up when the printer is not loaded with the paper size selected or when the paper feeding tray or paper cassette has run out of paper with Auto (auto paper selection) selected.
	PF*	Paper of the output bin was filled. <ul style="list-style-type: none"> • Remove the paper from the output bin.
---	PC	This blinks when the scanner is connected to the PC and ready for scanning by pressing the Start key.
	Pc	The scanner is not connected to the PC. <ul style="list-style-type: none"> • Turn on the PC or connect the scanner to the PC with the interface cable.
	L1	The lens is not mounted or is loose. <ul style="list-style-type: none"> • Check the lens for correct installation and reinstall it as necessary.
	L2	The projection lamp is burned out. <ul style="list-style-type: none"> • Turn the power off, unplug the power cord and replace the lamp. <p>If the lamp goes out during a print cycle, a blank print may be output.</p>
		Magnification warning display: <ul style="list-style-type: none"> • You used the modification of the magnification by an electronic zoom. • When a standard magnification is not selected, this symbol will be displayed.

Call your Service Representative if one of the following codes is displayed.			
Display	Location	Code	Description
	Scanner	C1	Optical path switch failure
		C2	A scanner malfunction
		C3	A condenser lens motor malfunction Shading correction malfunction
		C4	A fan motor malfunction
		C5	Imperfect auto focusing
	Printer	C6	A fusing unit malfunction
		C7	A LED malfunction
		C8	A polygon motor malfunction
		C9	A main drive motor malfunction
		CA	A fan motor malfunction
	Scanner Printer	C6	A communication malfunction (printer)
		CL	A printer clock malfunction
Scanner PC	CC	A communication malfunction (PC)	

Solving printing problems

Use the following procedures to fix minor printing problems. If print quality does not improve after implementing the procedures below, contact your Service Representative.

Symptom	Cause	Action
Light image 	Print density is not properly set. Toner in the toner cartridge is running out.	Change the print density setting as necessary. Replace the toner cartridge with a new one.
Dark image 	Print density is not properly set.	Change the print density setting as necessary.
Partial void image 	The paper in the tray is damp.	Replace the damp paper with fresh, dry paper.
Uneven image density 	Toner in the toner cartridge is not evenly distributed.	Remove the toner cartridge, shake it several times and replace.
Blank print 	The printer has malfunctioned.	Contact your Service Representative.

Appendix A Specifications

The following are specifications for the IMAGELINK 3000 DV Plus Digital Scanner and the 34 ppm Video Laser Printer.

NOTE: Specifications are subject to change without notice.

IMAGELINK 3000 DV Plus Digital Scanner

Specifications	
Type	Desktop-type microfilm scanner
Type of Film	Microfiche, Jackets, Aperture Cards, 16 mm & 35 mm Roll Film, 16 mm Film Cartridges
Magnification	7.5x, 9x-16x, 13x-27x, 20x-50x
Screen	303 mm x 440 mm (12 x 17 1/4")
Image Rotation	Prism rotation, Carrier rotation (fiche carrier)
Scanning Method	Scanning/Scanning direction: CCD scanning Scanning/Feeding direction: Mirror scanning
Exposure Control	Automatic and Manual
Light Source	Halogen lamp (DC20V 150W DDL Type)
Power Requirement	120 VAC (60Hz) or 220-240 VAC (50-60Hz)
Power Consumption	Less than 350W Auto Power Save mode: Less than 6W (120V areas) Less than 8 W (220V areas)
Dimensions	560(W) x 760(D) x 853(H) mm 22(W) x 30(D) x 33 1/2(H) inches
Weight	65 kg (143.25 lbs)
Standard Accessories	Power cord, printer cable, Prism Unit, User's Guide
Options	Projection Lenses, Fiche Carrier 5, Universal Carrier UC-2 and UC-8, Roll Film Carrier 15A/15M, MARS Mini Controller 2, Manual Frame Masking Unit, Auto Focus Unit, AF Lens Modification Kit, Foot Switch Kit, Grayscale Memory Board, USB Interface Kit (except for US/Canada), PC Interface Kit

PC Mode

Specifications	
Resolution	200, 300, 400, 600, 800 dpi
Output Scale	Binary, Grayscale (option)
PC Interface	USB 2.0 Hi-Speed SCSI-2 (option)

PR Mode - 34 ppm Video Laser Printer

Specifications	
Resolution	600 dpi
Output Scale	Binary
Printing Method	Laser Electrostatic
Developing System	Super Micro-Toning (Super-MT) System
Print Size	A3, A4 (portrait), A4 (Landscape) 11 x 17", 11 x 8 1/2", 8 1/2 x 11", 8 1/2 x 14"
Warm-up Time	Less than 70 seconds
First Print Time	19 seconds (11 x 17" or A3, 600 dpi, AE) 16.5 seconds (8 1/2 x 11" or A4, 600 dpi, AE)
Print Speed	18.5 sheets per minute (11 x 17" or A3, 600 dpi) 34 sheets per minute (8 1/2 x 11" or A4, 600 dpi)
Multiple Printing	1 to 99 sheets (LED countdown identification)
Paper Supply	Automatic Feeding Supply Paper Feeding Tray (200 sheets max.) Paper Cassette (500 sheets max.)
Printer's Power Consumption	Less than 1100 W
Printer's Dimensions	539(W) x 566(D) x 423(H) mm 21.2(W) x 22.2(D) x 17(H) inches
Printer's Weight	32.5 kg (71.75 lbs) including toner cartridge

Appendix B User and System Settings

This system offers these settings:



- User settings that are set up by the user from the control panel.
- Settings that are made by the user via User mode.
- System settings that are set up by the dealer.

Following is a list of factory settings:

User Settings	Initial Setting	Remark
Exposure mode	Auto	
Print image density	Center	
Paper size	Letter (A4)	
Film type	Auto	
Auto Skew Correction	OFF	
Auto Masking	OFF	
Manual Masking	-	Enabled only when the Manual Masking Kit (option) is mounted.
Centering/Fit	OFF	
Print position	Center	
Print mode	Text	
Resolution	600 dpi	34 ppm Video Printer
Electrical zoom magnification	1.00	

NOTE: When any of these functions are changed, store the new setting in the system's memory by pressing the **Memory Input** key.

System Setting	Selection	Initial Setting	Description
Auto Reset	Enabled Disabled	200V *	Setting changes made to the control panel that are not used within 60 seconds of being input are automatically cancelled and the system reverts back to the original settings.
Auto power save ON/OFF	Enabled Disabled	*	Sets the unit to enable or disable the Auto Power Save mode.
Printer Heater OFF (PR mode only)	Disabled 30 min. 60 min.	*	Turns the printer's heater off if the system is left idle for a specific period of time. Priority is given to the Power Save mode if Power Save has been set.
Auto Projection Lamp OFF	Disabled 30 min. 60 min.	*	Turns the projection lamp off if the system is left idle for a specified period of time. Priority is given to the Power Save mode if Power Save has been set.

System Setting	Selection	Initial Setting	Description
Fine mode contrast select	Contrast Emphasis Outline Emphasis	*	Applies the following functions as required: Contrast Emphasis: applied when film contains text that is poorly contrasted against its background making it difficult to read. Outline Emphasis: applied when film contains blurred black-and-white images.
Auto Skew Correction Retain	Retained Not Retained	*	Determines whether or not to retain the original (uncorrected) skew of a screen image after the print has been made.
Machine ID Printing (PR mode only)	Disabled Pattern 1 Pattern 2	*	When two scanners are connected to one printer, this function leaves an identification marker on the print so the scanner used for the job can be determined after printing. <div style="display: flex; justify-content: space-around; align-items: center;"> <div style="text-align: center;"> <p>Pattern 1</p>  <p>Paper</p> </div> <div style="text-align: center;"> <p>Pattern 2</p>  <p>Paper</p> </div> </div>
Cycle Print mode (PR mode only)	Enabled Disabled	*	This function automatically scans the next image following a preset period of time (the period can be set by your Service Representative). Images are set by the user onto the carrier glass in between cycles.
Paper Size of Paper Feeding tray (PR mode only)	Same as the setting for U4 of the User mode.		Determines the desired paper size and orientation from the paper feeding tray of the printer.
Contrast setting	Lighter Normal Darker	*	To view subtle images with standard ranges of density clearly: Light (-1 to -7). To bring out the darker and lighter ranges of an image: Dark (+1 to +7).
The print function at the time of Toner Empty or Toner Cartridge life detection (PR mode only)	<ul style="list-style-type: none"> • Empty>Disable • Print Life> Disable Print • Empty>Enable • Print Life> Disable Print • Empty>Enable • Print Life> Enable Print 	*	After a toner empty condition or toner cartridge life is detected, you can select to Stop or Continue printing. NOTE: When the selection of Enable Print after the toner cartridge life fulfillment has been reached, TE will be displayed while pressing the Start key.
Auto Film Format Select Print function (PR mode only)	Enable Disable	*120V *200V	The Auto Format Select Print function is enabled or disabled through the control panel.
90 degree rotation setting	Enable Disable	*	Enables the prism to rotate the screen image 90 degrees.

System Setting	Selection	Initial Setting	Description
Automatic paper source switching	Auto switching Disable Auto switching	*	<p>Allows you to specify the paper source when lettersize or A4 paper is loaded in lengthwise or crosswise orientations in the paper feed tray and the paper cassette.</p> <p>Auto switching: printing continues by automatically switching to the remaining paper source after paper in the specified paper source runs out.</p> <p>Disabling Auto switching: a Paper Empty mode occurs and printing stops after paper in the specified paper source runs out. The paper source must be refilled or the paper source must be switched by pressing the Output Selection key to resume printing.</p>

* To change any of the system settings described above, contact your Service Representative.

Appendix C Key Operator Information

When you need to call for service, be prepared to provide the following information:

- Your company name, address, telephone number, department name, floor number, machine location, etc.
- K# (Mainframe and/or Printer), model name, serial number, condition or system(s) indications(s) on the display, etc.

Model Name	IMAGELINK 3000 DV Plus Digital Scanner
	Serial Number K#
	IMAGELINK 34 ppm Video Laser Printer
	Serial No. K#
Attached Accessories	Serial No.
	Serial No.
	Serial No.
	Serial No.
	Serial No.
Installation Date	
Service Representative Phone #	

Appendix D Setting System Default Values

Changing settings with the User mode

User mode allows the default values of various functions to be set or changed as necessary. Most of these functions are set-up and changed by your Service Representative, however some User modes can be changed by you.

Setting these default values according to your needs saves time and allows you to work more efficiency. The following modes can be set:

Display	Function	Description
U1	Special Print mode	Not available.
U2	Engineering Enhancement mode	Corrects slight image distortion occurring in the scan direction.
U3	Auto Power Save	Used to set the time it takes the unit to be automatically set into the Auto Power Save mode.
U4	Paper Feeding Tray Size	Used to set the size and direction of the paper loaded in the paper feeding tray.
U5	Imprint Position Setting	Used to turn ON or OFF the Date Print and Character Overlay functions and to set the Date Print position.
U6	Year, Month, Date Set mode	Used to set the print pattern for the Date Print function.
U7	Imprint mode set	Used to correct the time of day for the Date Print function.
U8	Total Scan Counter	Used to display the number of scan sequences carried out by the scanner.

Entering and exiting the User mode

1. Hold down the **Shift** key and **Paper Selection** key at the same time for 0.5 seconds. The Multi-Print Display displays a "U".

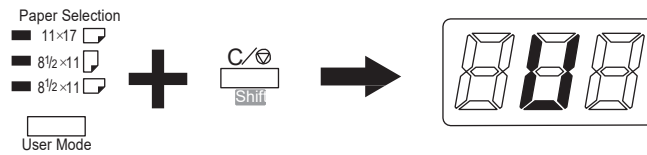

2. Press the **Exposure Adjustment** key (Darker or Lighter) to select the specific function.
 - Pressing the **Darker** key scrolls through the functions in the following order: U, U1, U2, U3, etc.
 - Pressing the **Lighter** key scrolls through the functions in the following order: U8, U7, U6, U5, etc.
3. Press the **Exposure Mode** key to display d(*). The asterisk indicates the current setting value.

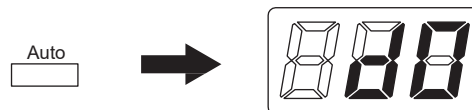

4. Press the **Exposure Adjustment** key (Darker or Lighter) to select the specific setting value.
 - Pressing the **Darker** key scrolls through the setting values in the following order: d0, d1, d2, etc.
 - Pressing the **Lighter** key scrolls through the setting values in the following order: d5, d4, d3, etc.
5. Press the **Start** key to validate the setting value.
6. Press the **Clear** key to exit User mode.

NOTES:

- If the **Exposure Mode** key is pressed, the setting value is not validated and the User mode initial screen (U) appears.
- If a new function is to be set, start the procedure over beginning with Step 2.

Settings in each User mode function

U1: Special Print mode — this function is not available.

U2: Engineering Enhancement mode — slight image distortion occurring in the scan direction can be corrected with this function.

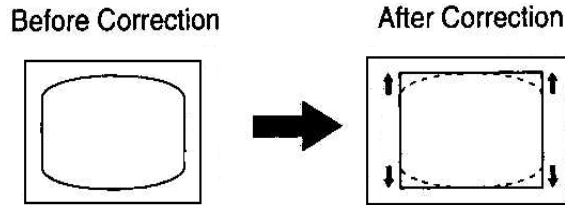

1. Select **U2** in the User mode.
2. Press the **Exposure Mode** key to display d*.
3. Press the **Exposure Adjustment** key (Darker or Lighter) to select the desired setting value.
4. Press the Start key to validate the setting.

NOTE: This setting returns to the default value when the power switch is turned off. You can register this setting by using the Job Program function.

Code	Setting Value	Initial Setting
d0	0 mm	
d1	0.5 mm	
d2	1.0 mm	
d3	1.5 mm	*
d4	2.0 mm	
d5	2.5 mm	
d6	3.0 mm	
d7	3.5 mm	
d8	4.0 mm	

U3: Auto Power Save — time it takes the unit to be automatically set into the Power Save mode.

1. Select **U3** in the User mode.
2. Press the **Exposure Mode** key to display d*.
3. Press the **Exposure Adjustment** key (Darker or Lighter) to select the desired setting value.
4. Press the **Start** key to validate the setting.

Code	Setting Value	Initial Setting
d1	Auto Power Save (15 min.)	*
d2	Auto Power Save (30 min.)	
d3	Auto Power Save (60 min.)	

U4: Paper Feeding Tray Size — the size and direction of the paper loaded in the Paper Feeding Tray can be set with this function.

1. Select **U4** in the User mode.
2. Press the **Exposure Mode** key to display d*.
3. Press the **Exposure Adjustment** key (Darker or Lighter) to select the desired setting value.
4. Press the **Start** key to validate the setting.

Code	Setting Value	Initial Setting
d0	Letter/A4 (portrait)	*
d1	Letter/A4 (landscape)	
d2	Ledger (A3)	
d3	Legal	

NOTE: d3 for USA and Canada only.

U5: Imprint Position — the Date Print and Character Overlay functions can be set to turn ON or OFF, and the date print position can be set with this function

The date print position is set on the screen, regardless of the paper feeding direction in the printer.

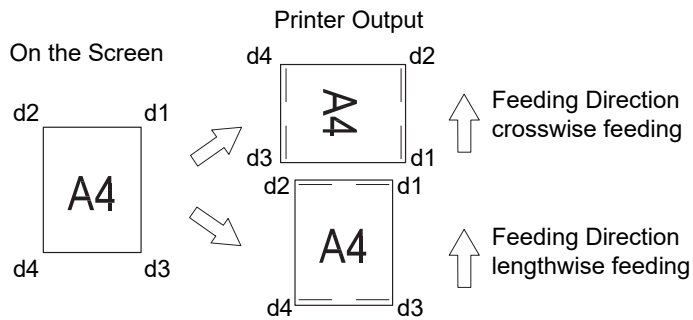

1. Select **U5** in the User mode.
2. Press the **Exposure Mode** key to display d*.
3. Press the **Exposure Adjustment** key (Darker or Lighter) to select the desired setting value.
4. Press the **Start** key to validate the setting.

Code	Setting Value	Initial Setting
d0	Turns OFF Date Print and Character Overlay functions	*
d1	Date Print function (upper right)	
d2	Date Print function (lower right)	
d3	Date Print function (upper left)	
d4	Date Print function (lower left)	
d5	Character Overlay function†	

† A personal computer and an interface kit are necessary only when the overlay data is transmitted to the scanner.

U6: Year, Month and Date Set mode —the print pattern for the Date Print function can be set with this function.

1. Select **U6** in the User mode.
2. Press the **Exposure Mode** key to display d*.
3. Press the **Exposure Adjustment** key (Darker or Lighter) to select the desired setting value.
4. Press the **Start** key to validate the setting.

Code	Setting Value	Initial Setting
d0	Year, month, day (2004.05.15)	
d1	Month day year (05 15 2004)	*(120V)
d2	Day month year (15 05 2004)	*(200V)
d3	Month, day hours:minutes (05.15 13:45)	

Year: 4 digits of dominical year

Month: 2 digits

Day: 2 digits

Hour: 2 digits (24-hour system)

Minutes: 2 digits

U7: Imprint mode set — when the time of day is incorrect, use the Date Print function to set the correct time.

1. Select **U7** in the User mode.
2. Press the **Exposure Mode** key. When the Exposure Mode key is pressed, both the Exposure Display and Multi-Print Display light up steadily.

NOTE: In the initial condition, the year default setting is displayed.

- Each time the **Darker** key is pressed, the Exposure Display scrolls upward to select the current setting mode in the following order: Month, Day, Hours, Minutes.
- Each time the **Lighter** key is pressed, the Exposure Display scrolls downward to select a setting mode.

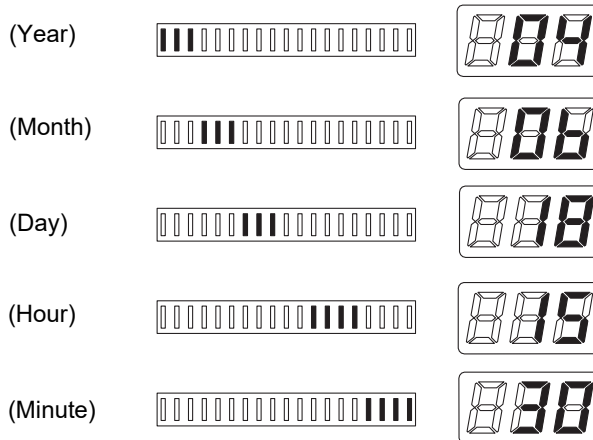

3. In each setting mode, press the **Multi-Print** key to enter the setting value. Each press of the **Multi-Press** key increases the setting value. When the value exceeds the maximum setting of the selected mode, it returns to 00 or 01 (month, day).
4. When the settings of all modes are complete, press the **Start** key to valid the time of day setting.

U8: Total Scan Counter — the number of scan sequences carried out by the scanner can be displayed with this function.

1. Select **U8** in the User mode.
2. Press the **Start** key. The current number of scan sequences by the scanner is displayed.



Eastman Park Micrographics
Dallas, TX. 75081
info@epminc.com

AGEUNK is a trademark of
Eastman Park Micrographics